



Master

CATALOG

» EDITION 19-7

MADE IN LANCASTER

COUNTRY
CLASSIC COLLECTION
★
Pennsylvania





GET TO KNOW US A LITTLE BETTER

When Elam Esh began building furniture in 1990 for a neighbor's woodworking shop, he studied furniture journals and built his own designs in his spare time. Soon, demand for his design led to a start-up business in a barn on his father's farm. At the suggestion of a friend, Elam found that his interest in balance and perception was a good match for the clean lines of Mission and Shaker style furniture. Over twenty-five years later, the Christian morals and hard work ethic of growing up on the farm continue to be the guiding principles behind the Country Classic Collection, delivering strong value and honesty in both our designs and relations. Today, the Country Classic Collection continues to grow with a beautiful selection of Mission, Shaker, Contemporary, and Modern styles, Amish handcrafted in the heart of Pennsylvania Dutch country.

WE STAND BEHIND WHAT WE BUILD

Our Promise To You

- » We promise the handcrafted furniture you purchase is free from defects in material and workmanship for the life of the product.
- » We promise that, if the furniture should fail as a result of defective workmanship, we will repair it, or replace it, with the same or similar piece of furniture.

What We Hope You Never Have To Do

- » But in the event you need to make a claim, we're always here to help. Simply contact the store that you bought your furniture from, and we will make things right.

BUILT TO SATISFY

CUSTOM, LEAN AND AGILE

What we do and why we do it

Yes, we build furniture, but the reason we are here is to serve you. We are primarily in the business of satisfying customers. We do that by embracing lean techniques – doing more with less. We are constantly working on eliminating waste and making the best use of the precious resources God has provided us. By doing this with both our time and materials, we can achieve our goal of exceeding your expectations by continuously delivering more for less!

Go ahead - Customize it!

Because of these innovations in lean manufacturing, each piece is built to order for you with your choice of color, hardware and wood species, as well as any size changes you may need. We can change sizes on any piece to make it longer, higher or wider. You can even add drawers and doors to get exactly what you want.



COUNTRY CLASSIC COLLECTION

OPTIONS

SPECIES
COLORS
HARDWARE
BONDED LEATHER
DIMENSIONAL CHANGES

OPTIONS



★ CUSTOMIZE IT ★
MAKE IT
UNIQUELY
Yours

STANDARD ORDER PROCESS

Follow these simple steps. You will be directed by the icons below to help you through the Order Process on the following Options pages.

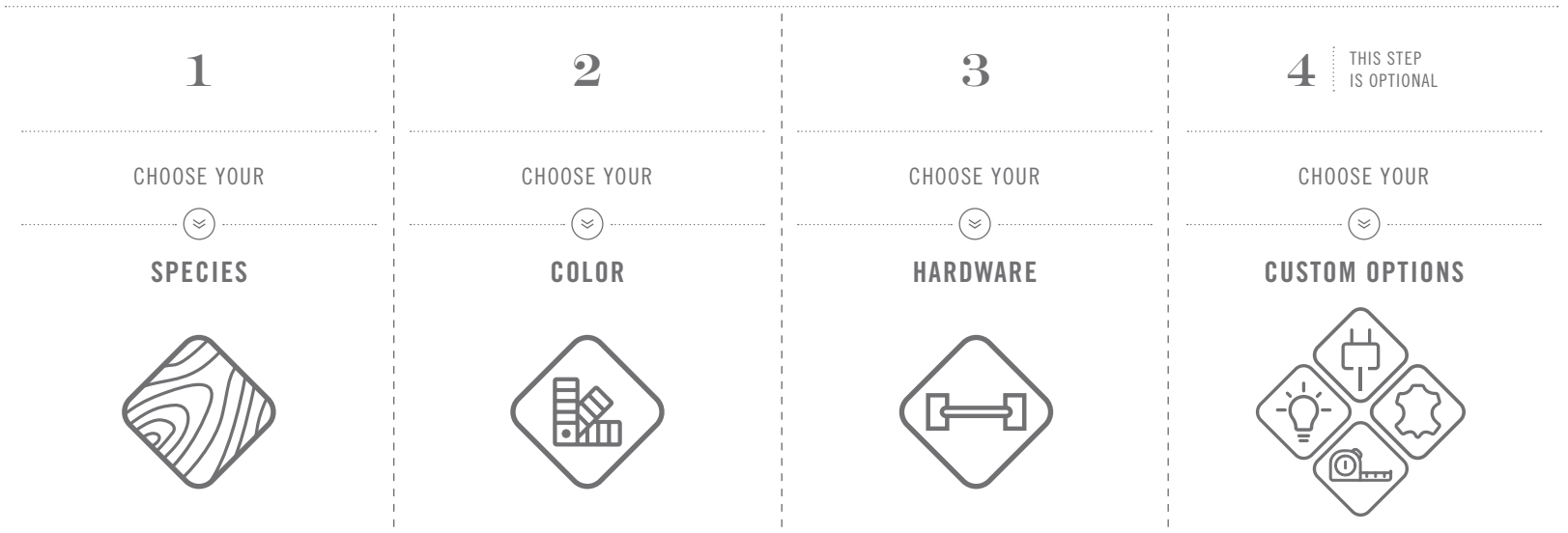

OPTIONAL DIMENSION & COMPONENT CUSTOMIZATION

If you love our furniture but need a custom size or feature follow this process to create it.

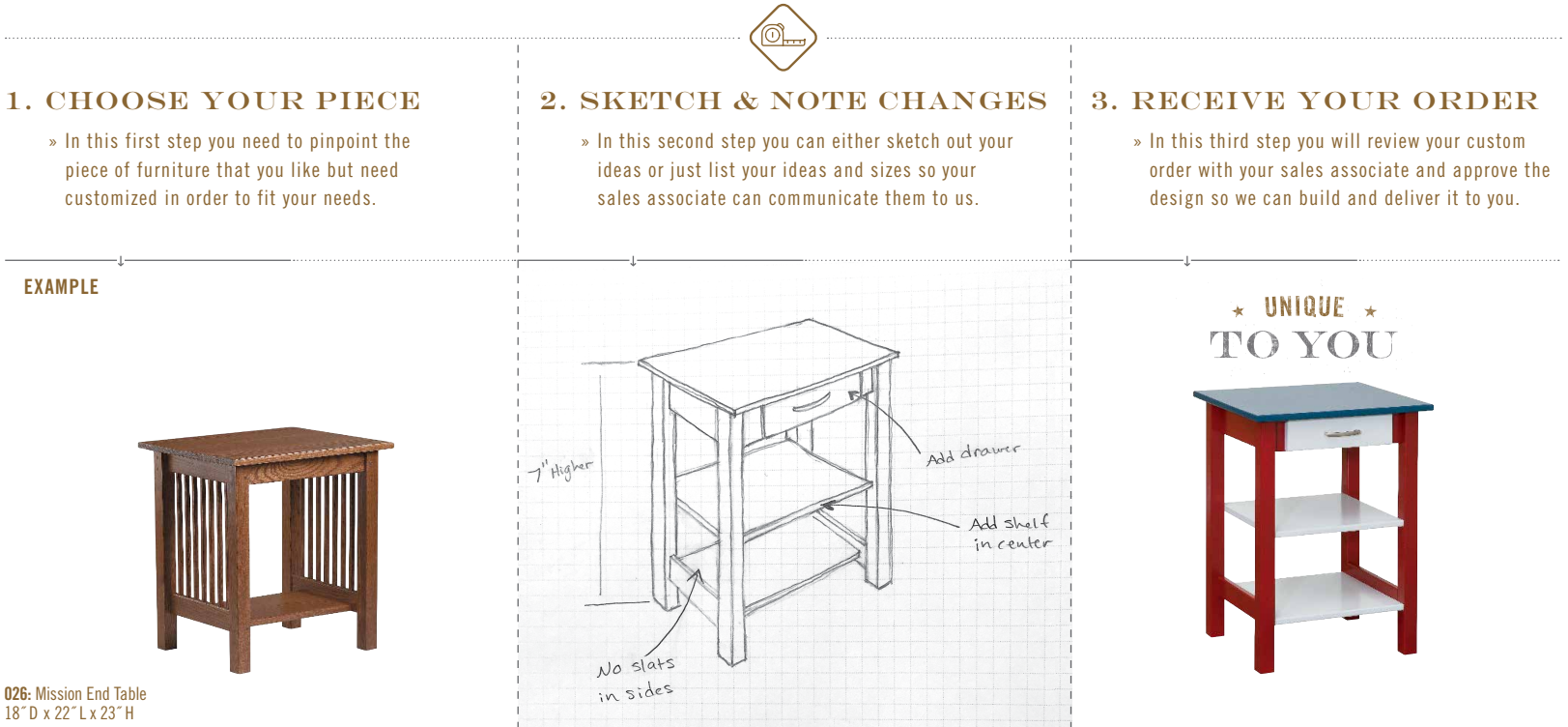

026: Mission End Table
18" D x 22" L x 23" H

★ IMPORTED ★
FROM
ABSOLUTELY
Nowhere

LANCASTER COUNTY, PA
IS MORE THAN JUST A PLACE...

Our heritage and culture is deeply rooted in this fertile land of the free. The strong work ethic and Christian morals of our forefathers and their integrity and meticulous stewardship of the land are now reflected in the work of our Craftsmen. Our strong belief in “honor others above thyself” means we are here to assist you with personal and helpful service. It also means we believe in building our furnishings with excellent value at a fair price. It means crafting furnishings that you can pass on to your children’s children just like our heritage was passed down to us.

CELEBRATING ★ *30* Years ★ COUNTRYCLASSICCOLLECTION.COM

FEATURES

The following features are standard hallmarks you will appreciate on every piece of the Country Classic Collection.



SOLID
HARDWOOD
CONSTRUCTION



DOVETAILED
DRAWERS



HARDWARE
CHOICES



COLOR
CHOICES



HARDWOOD
CHOICES

ICON INDEX

Look for these helpful icons throughout the catalog for a quick reference to product features.



AVAILABLE
IN LEATHER



SOLID WOOD
GEAR DRIVEN
TABLE SLIDES



FULL
EXTENSION
DRAWER GLIDES



100LB +
FULL EXTENSION
DRAWER GLIDES



OPTIONAL
POWER PORTS



ADJUSTABLE
SHELVES



LED
LIGHTING



LED TOUCH
LIGHTING

KEY SERVICES

1. Customization of dimensions & components
2. Short, Dependable Turnaround. One of the best in the industry.
3. Quick, reliable responses

- » We offer the full line of OCS stains with 30+ choices as well as two-tone, unfinished, and eight solid paint colors.
- » Specialty finish options including: LD = Light Distressing and AT = Antiquing/ Heavy Distressing.
- » Free Sales Aids including large binder, trifold brochures, bedroom and dining room tear-off sheets, product warranty cards, order forms, and a file sharing service showing all of our products, stains, and hardware choices.
- » We have a solid guarantee and stand behind our product.

Design Centers Available

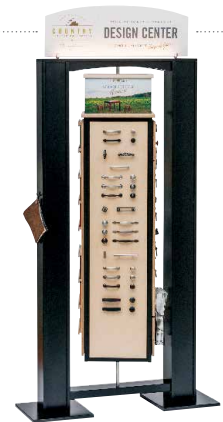

ORDERING INSTRUCTIONS

When placing an order, always use the part number and specify stain color, hardware choice, and wood species. We have order forms available for you to use for your convenience and have extra copies available upon request. Confirmations are given on all orders that we receive along with an estimated completion date. Upon completion of your order, you will receive confirmation it is ready to ship or pick up.

WOOD, COLOR AND HARDWARE CHOICES

The next section shows all of our OCS stains on Red Oak, Cherry, Maple, and Quarter Sawn White Oak as well as detailed pictures of all our hardware choices. There is also a section showing bonded leather choices. Actual samples are available for a truer representation.

» Thank you for choosing the Country Classic Collection!

MEMBER OF:



MEMBER OF:



BUILT WITH:



CONSTRUCTION FEATURES



SOLID AMERICAN HARDWOODS
Sustainable, enduring! Truly grown and raised in America.



DURABLE FINISH
Durable catalyzed conversion finish that is extremely resistant to liquids and most household chemicals. Because life happens.



COUNTRY CLASSIC BRAND
Each piece is proudly branded with the Country Classic Collection logo: Made in P.A.



ATTENTION TO DETAIL
Our Craftsmen care about details. The underside gets the same treatment as the top, stained, sealed, sanded and finished.



DOVE TAILED DRAWER
All drawers are solid Maple wood with a natural finish.



FULL EXTENSION DRAWER SLIDE
All items come with quality, full extension, ball bearing slides. (except 001-059-084)

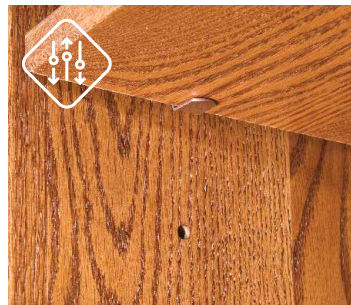

ADJUSTABLE SHELVING
Our entertainments, chinases, and select cabinets have adjustable shelves for easy customization.



OPTIONAL POWER
AC & USB ports available on select items.



TIP-OVER RESTRAINT
Restraint provided to help reduce the chance of tip-over in larger drawer units.



EDUCATIONAL INSTRUCTIONS
Look for instructions on how to help prevent tip-overs in the top right drawer on larger case pieces.



100LB SLIDES
Larger Bedroom and Dining Room pieces come standard with 100lb capacity slides.



DINING FEATURES



TABLE TOPS
Our dining tables come standard with 1" thick solid wood tops.



EXTENSION TABLE GLIDE
Gear-driven double equalizer extension glides are standard on most extension tables.



CORNER LEG BRACKET
All optional legs are double bolted to ensure stability.



CHAIR CONSTRUCTION
Sturdy, enduring chair construction. Built for life, made for living.



TOUCH LIGHTING
All chinases have our unique dimmable touch lighting with long-lasting LED lights.

---- COMPARE ----

THE DIFFERENCE

American Made



COUNTRY CLASSIC COLLECTION

1. » **DURABLE FINISH**
Durable catalyzed conversion varnish that is extremely resistant to liquids and most household chemicals and withstands years of wear. **So durable it gets used on flooring!**
2. » **SOLID HARDWOOD**
Top is made of $\frac{3}{4}$ " solid American hardwood.
3. » **STURDY HARDWOOD LEGS**
Strong, sturdy legs are cut out of one piece of solid American hardwood.
4. » **SOLID FRONTS**
Drawer fronts made of substantial $\frac{3}{4}$ " solid American hardwood.
5. » **STURDY MAPLE BOX**
Drawer box made of $\frac{1}{2}$ " solid maple and sealed and finished with the same high quality varnish as the top and rest of unit.
6. » **METAL FULL EXTENSION**
Metal heavy duty ball-bearing slides that allows for Full Extension. Drawer opens and closes smoothly, is sturdy and long-lasting.
7. » **STRONG SIDES**
Sides are made of the same $\frac{3}{4}$ " solid American hardwood that the top is made of. You or your kids will not break these sides!
8. » **SOUND, REINFORCED BOTTOM**
Substantial $\frac{1}{2}$ " bottom pocket screwed with $1\frac{1}{4}$ " screws. This reinforces the stability and solidness of the piece.

---- COMPARE ----

THE DIFFERENCE

Imported



IMPORTED

1. » **INFERIOR FINISH**
Susceptible to damage from exposure to liquids, hot products and household chemicals.
2. » **WEAK PARTICLE BOARD TOP**
Top is made of weak $\frac{1}{2}$ " MDF particle board.
3. » **INSUBSTANTIAL LEGS**
Insubstantial legs with multiple pieces of soft wood glued together to give a false appearance of solid legs.
4. » **THIN PARTICLE BOARD**
Drawer fronts made of thin $\frac{1}{2}$ " MDF plywood.
5. » **CHEAP DRAWER BOX**
Drawer box made of cheap particle board with a fake laminated wood pattern on it to give a false appearance of real wood.
6. » **FLIMSY, PLASTIC 3/4" SLIDES**
Plastic clip drawer slide that is loose and flimsy and only allows for $\frac{3}{4}$ " extension. Drawer opens irregularly, tends to wiggle side to side and up and down, has very little support and will tear out rather easily with use.
7. » **FRAGILE PLYWOOD SIDES**
Sides are made of skimpy $\frac{1}{4}$ " plywood that is easily cracked or broken.
8. » **WEAK BOTTOM**
Fragile $\frac{1}{4}$ " particle board bottom fastened with staples. This thin bottom makes the entire piece less stable and allows entire unit to twist and torque.

PRODUCT *Warranty*

OUR PROMISE TO YOU

- » We promise the handcrafted furniture you have purchased today is free from defects in material and workmanship for the life of the product.
- » We promise that, if the furniture should fail as a result of defective workmanship, we will repair it, or replace it, with the same or similar piece of furniture.

WHAT WE ASK IN RETURN

- » We ask that you use the furniture for the purpose for which the piece was designed.

COMMON SENSE WE CAN AGREE ON

- » Normal wear and tear, seasonal splits, or damage related to alteration, accident, misuse, improper care, or negligence are not within reason, and should not, and do not apply to this guarantee.

WHAT WE HOPE YOU ENJOY

- » A lifetime of use, beauty, and peace of mind knowing the craftsmen you purchased your furniture from stand behind the integrity of their work.

WHAT WE HOPE YOU NEVER HAVE TO DO

- » But in the event you need to make a claim, we're always here to help. Simply contact the store that you bought your furniture from and we will make things right. If it is necessary to return the product to our workshop, the purchaser is responsible for all packing and shipping costs. Thank you for putting your trust in our dedicated craftsmen!

ENVIRONMENTAL *Control*

Our high-quality home furnishings are crafted with genuine, solid wood which is a natural fiber. It will take on and release moisture as Relative humidity (RH) changes with the seasons. Avoiding extreme RH (below 30% or above 65%) is beneficial for maintaining the great function and beauty for generations;

- » Maintain relative humidity at *35-45%

Note: Low RH, i.e. 30% or less is usually more of a concern than higher RH.

- » Avoid placing your furniture in direct sunlight or near vents and heat sources such as radiators or stoves.
- » Avoid storing in uncontrolled environments such as; garages, basements and attics

* There are a few things that can be done to maintain RH. The best of course being to run a humidifier in the winter and a dehumidifier in the summer.

FURNITURE *Cleaning*

We recommend using a soft, damp cloth wiping with the grain. This is all that is needed to keep your furnishings looking great!

- » Avoid dusting with a dry cloth as this may cause small scuffs in your premium finish. If you desire to use a cleaner or furniture polish, avoid using ones that contain ammonia or silicone.
- » Clean up spills using warm water and a mild soap if necessary. While our finish is EXTREMELY chemical & water resistant standing liquids and solvents can cause damage with time.
- » Although not necessary, waxing regularly with a certified, furniture wax can enhance the life and luster of your hardwood furniture.

BUILT TO SATISFY

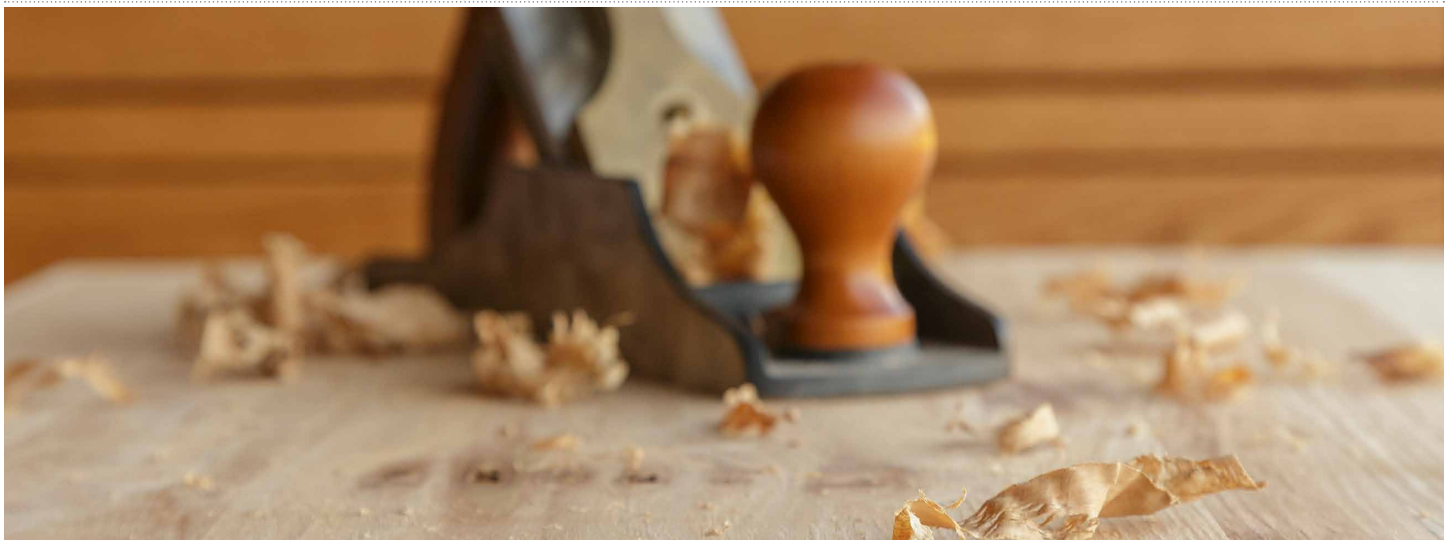

AMISH MADE

COUNTRY CLASSIC *Updates*

NEW COLLECTIONS

FARMSTEAD BEDROOM



715: Farmstead Queen Bed

SIMPLICITY OCCASIONALS



434: Wedge Table

SIMPLICITY BEDROOM



455: Simplicity Queen Bed

NEW ADDITIONS

OCCASIONAL: SIMPLICITY



437: Simplicity Lift Top Chairside Table

OCCASIONAL: CROSSWAY



722: Crossway Gathering Console

BEDROOM: MISSION



212: Bedstep 22"

NEW OPTIONS

» (See also hardware options page)



B1128-B: Belcastel Pull
5" C-C



B1K-B: Belcastel Knob

» New Colors:

SHOWN ON CHERRY WOOD



COC: Cocoa / ocs 122

SHOWN ON RED OAK WOOD



COC: Cocoa / ocs 122

SHOWN ON QUARTER SAWN WOOD



COC: Cocoa / ocs 122



RED OAK, MAPLE, WORMY MAPLE, HICKORY, RUSTIC HICKORY, QUARTER SAWN WHITE OAK, CHERRY or RUSTIC CHERRY.

First decide which hardwood you are most interested in. Each has its own distinctive characteristics. Each piece gets built with many individual boards and you may notice some natural variation in color. Lighter boards come from closer to the bark of the tree and vice versa for darker ones. This is a hallmark of genuine hardwood furniture and a stamp of authenticity! No two boards are alike and every piece we build is a unique work of Nature.

» RH: RUSTIC HICKORY

All the strength and durability you would expect from grade Hickory but with the added beauty of knots and pits. Large knots and pits get filled with black epoxy while smaller ones are left open to farther accent the true character of this arresting hardwood. Tell a story – make a statement. Revel in nature's handiwork.



» H: HICKORY

If you are looking for strength, hardness, and durability, Hickory is the most viable wood in North America. The grain is normally straight, but can sometimes be irregular or wavy. Hickory has a coarse texture, with a great deal of color variation between reddish brown, lighter brown, and white. Color variation may have a striped appearance. If your design tastes are for natural wood tones this is one that makes quite an impression.



» O: RED OAK

A beautiful hardwood chosen 50% of the time by Americans for their home furnishings. With three dimensional warmth, relatively uniform color and great durability this species is a popular choice for a reason. It has long been an American staple being the most widely used and purposeful wood even back in the colonial days.



» QS: QUARTER SAWN WHITE OAK

This wonderful wood has characteristics very similar to Red Oak, though rarer. When ¼ sawn it provides “ray flake”. Ray flake is the distinctive striping which comes from cutting the log cross grain. Commonly referred to as Tiger striping. This method and look is prevalent on many antique furniture pieces. Gustave Stickley and the Shakers popularized this high end look with their signature styles which is why Mission and Shaker style pieces are still often displayed in this premium wood.



» C: CHERRY

Found all across the Northeastern shore especially in the Appalachian areas. The finest growth occurs right here in our home state of PA and in West Virginia. The lighter reddish-brown tones create a warm, luxurious look that has made it a favorite for state rooms and mansions which is why this species has become synonymous with wealth and quality. It includes small pitch pockets of mineral and is susceptible to UV and will always darken with exposure to light.



» RC: RUSTIC CHERRY

The same wood as Cherry but with the natural beauty of the “heart wood” (from the center of the tree). This arresting choice contains more of the “sap wood” and “pitting” than standard cherry as well as knots and natural cracks and splits. The character forms a unique and rustic appearance with and unexpected flare that makes a striking statement.



» M: MAPLE (UNSELECTED)

Grown and sustainably harvested from the Great Lakes to the Appalachian mountains. Maple has a durable, tight grain structure. Its tones are more yellow and creamy than cherry. However, it is growing in popularity and has surpassed cherry in preference and is more affordably priced. The luster and changing beauty it creates as light infuses it from different angles plus the natural coloration makes Maple one of the most attractive American hardwood choices available. We use mostly “heart wood” thus the color tones vary from light to beige to dark brown.



» WRM: WORMY MAPLE

Wormy Maple is regular Maple's assertive sibling. It is graded from standard Maple because of the “sap streaks” that naturally occur in this species. It is also separated because of its “worm holes”. Even though it is called wormy the darker streaks are not caused by a worm. They are actually caused by the ambrosia beetle. They leave larvae behind which bore a shallow channel and deposit a fungus that causes the discoloration. These areas are structurally sound. The dark streaks combined with the “worm holes” give it a charming and naturally rustic appeal. Especially when finished in Natural or lighter finishes.





SHOWN: O / Red Oak

084: Shaker Catchall



SHOWN: C / Cherry

221C: Cherry Mission Mule Chest



SHOWN: RSO / Rustic Oak

764: Farmstead Three Drawer Nightstand



SHOWN: RC / Rustic Cherry

261: Craftsmen Dresser



SHOWN: RH / Rustic Hickory

424: Simplicity Console Table



SHOWN: H / Hickory

506: Shaker Chairside with Door



SHOWN: M / Maple

045G: Mission Large Coffee Table with Display



SHOWN: WRM / Wormy Maple

054: Shaker Wedge Table





Select the premium OCS (Ohio Certified Stain) color that resonates with your design tastes. Our broad and beautiful palettes of colors are hand applied and meticulously checked for consistency by our Craftsmen that are passionate about your satisfaction. Finishworks colors and Custom color matches also available upon request.

ALL COLORS ARE AVAILABLE ON ANY SPECIES!

Color is influenced by the grain and species of the wood. These printed samples may not be an exact wood grain or stain representation. **NOTE:** Actual wood samples are available for a truer representation of our OCS colors.



NOTE: A select variety of color samples are available on different species. Or, for a complete set of 7" x 10" color samples contact: **Ohio Certified Stains Ph 330.275.7784**

» SHOWN ON OAK WOOD

Most Popular Choices

» **ALL COLORS ARE AVAILABLE ON ANY SPECIES.**
Unfinished and two-tone colors are also available.



SLY: Seely / ocs 104



PRO: Provincial / ocs 112



HAR: Harvest / ocs 116



MC: Michaels / ocs 113



CAP: Cappuccino / ocs 119



RT: Rich Tobacco / ocs 228

» SHOWN ON CHERRY/RUSTIC CHERRY WOOD



NAT: Natural / ocs 100



HAR: Harvest / ocs 116



MED: Medium / ocs 110



MC: Michaels / ocs 113



ASB: Asbury / ocs 117



RT: Rich Tobacco / ocs 228

» SHOWN ON MAPLE WOOD

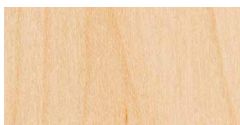

NAT: Natural / ocs 100



SLY: Seely / ocs 104



HAR: Harvest / ocs 116



SMO: Smoke / ocs 121

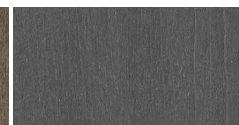

SLT: Antique Slate / ocs 118

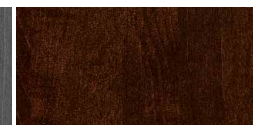

RT: Rich Tobacco / ocs 228

OCS PAINT OPTIONS

STEP

2



CHOOSE YOUR
COLOR

» SHOWN ON MAPLE WOOD

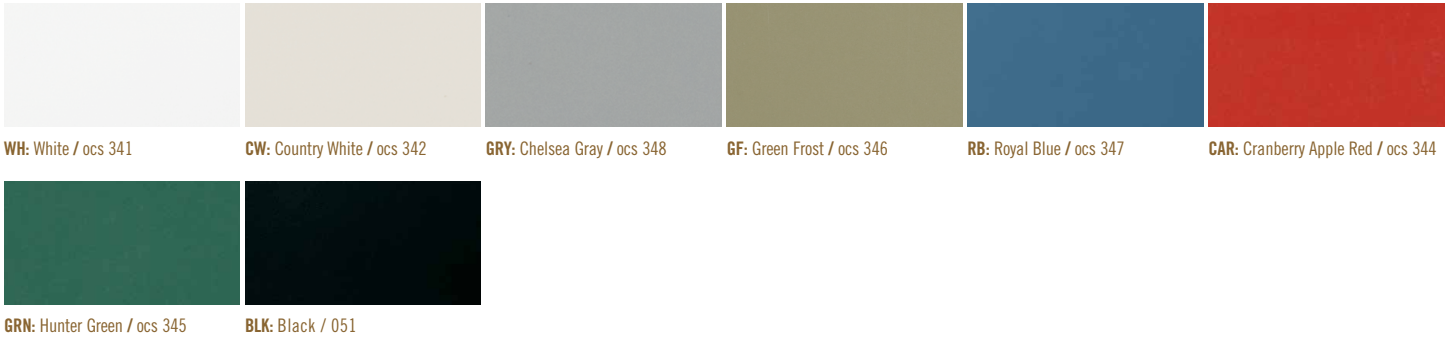

» SHOWN ON OAK WOOD

More OCS Finish Choices

ALL COLORS ARE AVAILABLE ON ANY SPECIES.
Unfinished and two-tone colors are also available.

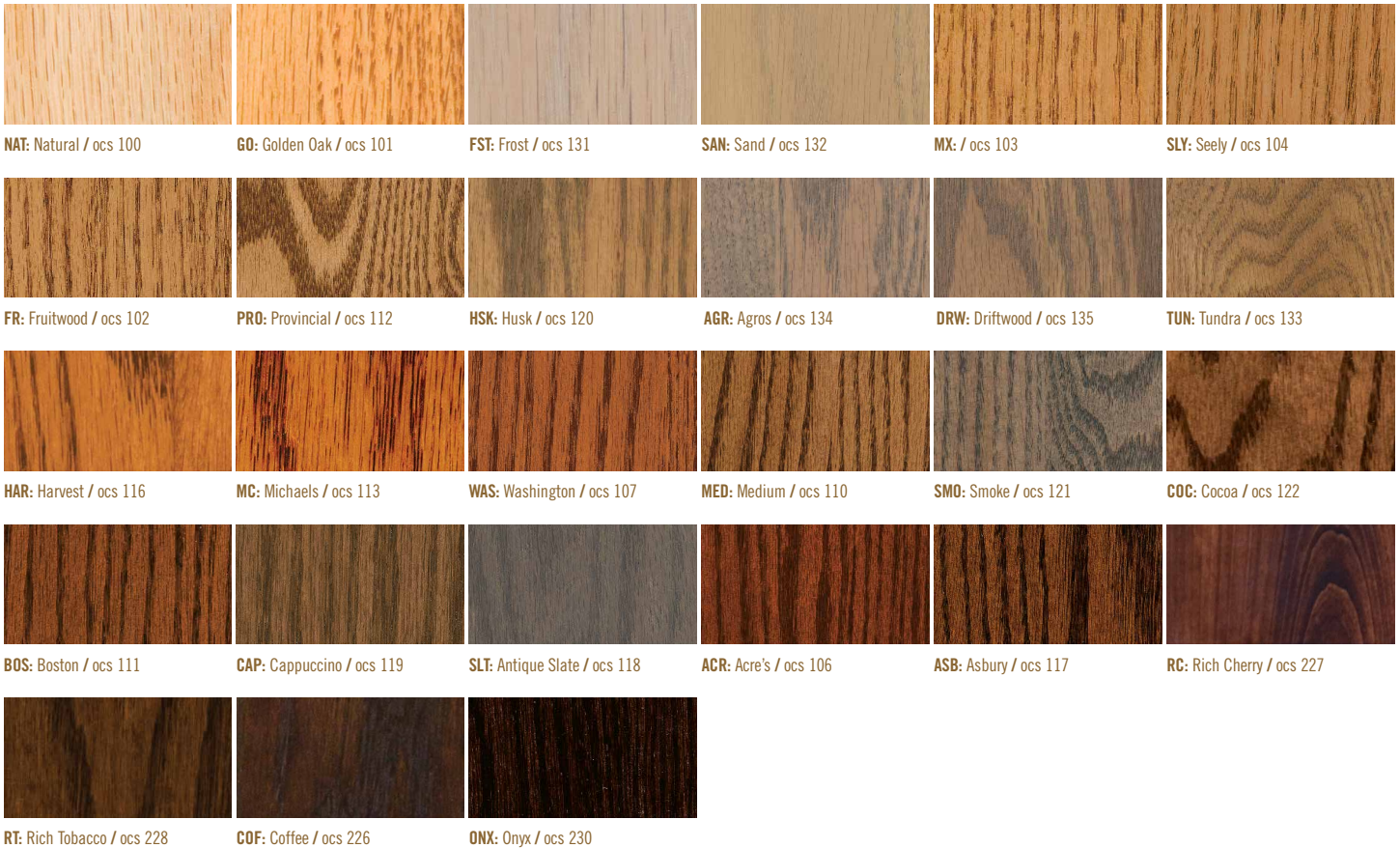

» SHOWN ON MAPLE WOOD

» **ALL COLORS ARE AVAILABLE ON ANY SPECIES.**
Unfinished and two-tone colors are also available.



FST: Frost / ocs 131

SAN: Sand / ocs 132

TUN: Tundra / ocs 133

AGR: Agros / ocs 134

DRW: Driftwood / ocs 135

GO: Golden Oak / ocs 101



SLY: Seely / ocs 104

SMO: Smoke / ocs 121

MC: Michaels / ocs 113

BOS: Boston / ocs 111

CAP: Cappuccino / ocs 119

SLT: Antique Slate / ocs 118



COF: Coffee / ocs 226

ASB: Asbury / ocs 117

BC: Bing Cherry / ocs 229

RC: Rich Cherry / ocs 227

RT: Rich Tobacco / ocs 228

» SHOWN ON CHERRY/RUSTIC CHERRY WOOD

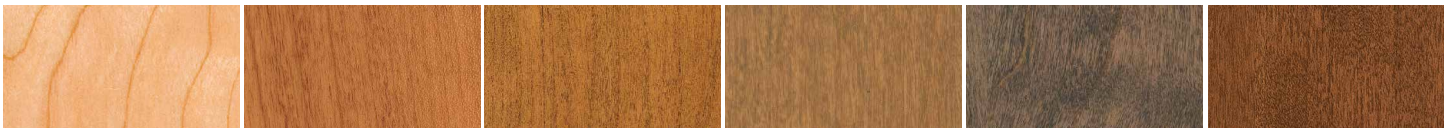

NAT: Natural / ocs 100

MX: / ocs 103

SLY: Seely / ocs 104

HSK: Husk / ocs 120

SMO: Smoke / ocs 121

MED: Medium / ocs 110

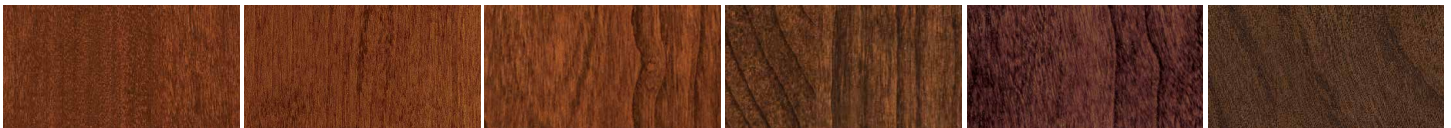

WAS: Washington / ocs 107

MC: Michaels / ocs 113

ACR: Acre's / ocs 106

COC: Cocoa / ocs 122

BOS: Boston / ocs 111

CAP: Cappuccino / ocs 119

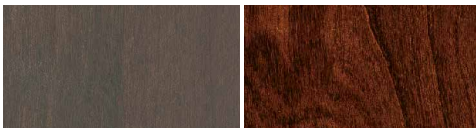

SLT: Antique Slate / ocs 118

ASB: Asbury / ocs 117

» SHOWN ON QUARTER-SAWN WOOD



HSK: Husk / ocs 120

SMO: Smoke / ocs 121

CAP: Cappuccino / ocs 119

MC: Michaels / ocs 113

BOS: Boston / ocs 111

COC: Cocoa / ocs 122



ASB: Asbury / ocs 117

SLT: Antique Slate / ocs 118

Color is influenced by the grain and species of the wood. These printed samples may not be an exact wood grain or stain representation. **NOTE:** Actual wood samples are available for a truer representation of our OCS colors.

» **NOTE:** For a complete set of 7" x 10" color samples contact: **Ohio Certified Stains Ph 330.275.7784**



Specialty Finishes

ADD A DISTINGUISHED APPEAL

» **Distressing and Two Tone are available in ANY color and on ALL species.**
Simply add the Codes below before the OCS Color you choose. (Specialty charges may apply)

LD: Light Distressing

Worm holes, light splits and light dents all highlighted with glaze to give it an aged appearance.



AT: Antiquing

Worm holes, heavy splits, dents, gouges and worn and filed edges are all highlighted with a brushed glaze to give it an antiquated appearance.



RP: Rub Through with Provincial (brown) Glaze

Rub through edges are highlighted with brown glaze to give it a worn appearance.



RG: Rubthrough with Graphite (grey) Glaze

Rub through edges are highlighted with a grey/charcoal glaze that gives a weathered and worn appearance.



2T: Two Tone

With your choice of any 2 stain or paint color combinations.





The following hardware options are available **on all collections**. This gives you the choice to create your own unique look to fit your style.



CP-NK: Cup Pull Knob
Weathered Nickel



CP-N: Cup Pull
Weathered Nickel 3" C-C



SM-BD: Stickley Mission Door Pull
Black 3" C-C



SM-B: Stickley Mission Pull
Black 3" C-C



SM-ED: Stickley Mission Door Pull
Antique English 3" C-C



SM-E: Stickley Mission Pull
Antique English 3" C-C



SM-CD: Stickley Mission Door Pull
Antique Copper 3" C-C



SM-C: Stickley Mission Pull
Antique Copper 3" C-C



W-CD: Window Mission Door Pull
Antique Copper 3" C-C



W-C: Window Copper Pull
Antique Copper 3" C-C



W-BD: Window Mission Door Pull
Black 3" C-C



W-B: Window Mission Pull
Black 3" C-C



KS-PK: Keystone Knob
Pewter



KS-P: Keystone Pull
Pewter 3" C-C



M-BD: Mission Door Pull
Black 3" C-C



M-B: Large Mission Pull
Black 3" C-C

» **NOTE:** Knobs will be used on doors if style has a knob option. Unless otherwise noted!



E-BK: Economy Knob
Black



E-B: Economy Pull
Black 3" C-C



E-SK: Economy Knob
Silver



E-S: Economy Pull
Silver 3" C-C



BP-SK: Bar Pull Knob



BP-S: Bar Pull
Silver 3" C-C



WK: Wooden Knob



CM-S: Contemporary Madison Pull
Silver 96 mm



CR-BK: Craftsmen Knob



CR-B: Craftsmen Pull
Black 3" C-C



AD-SK: American Diner Knob
Silver



AD-S: American Diner Pull
Silver 3" C-C



AD-VK: American Diner Knob
Venetian Bronze



AD-V: American Diner Pull
Venetian Bronze 3" C-C



B-NK: Bell Iron Knob
Weathered Nickel



B-N: Bell Iron Pull
Weathered Nickel 3" C-C



B-OBK: Bell Iron Knob
Oil Rubbed Bronze



B-OB: Bell Iron Pull
Oil Rubbed Bronze 3" C-C



B-SK: Bell Iron Knob
Silver



B-S: Bell Iron Pull
Silver 3" C-C



F-BK: Forgings Knob
Black



F-B: Forgings Pull
Black 3" C-C



F-OBK: Forgings Knob
Oil Rubbed Bronze



F-OB: Forgings Pull
Oil Rubbed Bronze 3" C-C



P-NK: Palisade Knob
Weathered Nickel



P-N: Palisade Pull
Weathered Nickel 3" C-C



P-OBK: Palisade Knob
Oil Rubbed Bronze



P-OB: Palisade Pull
Oil Rubbed Bronze 3" C-C



P-SK: Palisade Knob
Silver



P-S: Palisade Pull
Silver 3" C-C



Z-NK: Zephyr Knob
Weathered Nickel



Z-N: Zephyr Pull
Weathered Nickel 3" C-C



Z-OBK: Zephyr Knob
Oil Rubbed Bronze



Z-OB: Zephyr Pull
Oil Rubbed Bronze 3" C-C



Z-SK: Zephyr Knob
Silver



Z-S: Zephyr Pull
Silver 3" C-C



IF-N: Iron Forgings Pull
Weathered Nickel 96mm C-C



IF-NK: Iron Forgings Knob
Weathered Nickel



BF-BK: Belfast Knob
Black



BF-B: Belfast Pull
5" C-C

» **NOTE:** Knobs will be used on doors if style has a knob option. Unless otherwise noted!



ML-BK: Milan Knob
Gun Metal Black



ML160-B: Milan Pull
Gun Metal Black 6 1/4" C-C



ML96-B: Milan Pull
Gun Metal Black 3 3/4" C-C



LY-OBK: Leyton Knob
Oil Rubbed Bronze



LY128-OB: Leyton Pull
Oil Rubbed Bronze 5" C-C



LY96-OB: Leyton Pull
Oil Rubbed Bronze 3 3/4" C-C



B1-BK: Belcastel Knob
Gun Metal Black



B1128-B: Belcastel Pull
Gun Metal Black 5" C-C



B1128-OB: Belcastel Pull
Antiqued Bronze 5" C-C



B1-OBK: Belcastel Knob
Antiqued Bronze



ST192-SBZ: Stanton Pull
Satin Bronze 7 1/2" C-C



ST128-SBZ: Stanton Pull
Satin Bronze 5" C-C



ST-SBZK: Stanton Knob
Satin Bronze



ST128-B: Stanton Pull
Black 5" C-C



ST-BK: Stanton Knob
Black





OPTIONAL POWER PORTS

OPTIONAL LIGHTING



P-6 POWER PORT



H-2 POWER PORT



H-L3 POWER PORT



P-22 POWER PORT

OPTIONAL POWER ICON: Look for products with this icon.

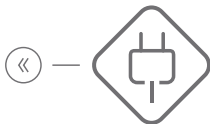

OPTIONAL ACCENT LIGHTING ON SELECT MIRRORS.



OPTIONAL ACCENT LIGHTING ON SELET BEDS.



OPTIONAL TASK LIGHTING ON SELECT ITEMS



OPTIONAL LED LIGHTING ICON: Look for products with this icon.

BONDED LEATHER

Options

STEP
4



CHOOSE YOUR
CUSTOM
OPTIONS

SARANO COLLECTION

This antiqued leather look with expressive cowhide grain and the harmonic two-tone effect lends this collection a natural vividness that gives you the look and feel of real leather with the added benefits of increased durability and superior resistance to fading. These colors are sure to add charm in any setting. These beautiful faux leather options are available on most dining, office chairs and bar stools as well as other select items. It is extremely durable, UV resistant and easy to clean. Choose from the variety of color tones below to match your taste.



SPECS



LONG LASTING



UV RESISTANT

UV RESISTANT: +300 hours
ASTM G154-QUV



TEAR RESISTANT



EASY TO CLEAN

Clean with mild soap and warm water



ABRASION RESISTANT

50,000 + DOUBLE RUB - Wyzenbeck
(Compare to most commonly used materials 15,000 double rubs)
ASTM D4157-/CFFA-1A

FACE: 97% Virgin Vinyl BACKING: 100% Cotton Fabric FLAME PROTECTION: Caf. Bulletin 117 E., UFAC/NFPA260 Class1, DIN EN 1021-1+2 - May comply with California 133 when tested with suitable components



BL: Black Anthracite



CHO: Chocolate



BUF: Buffalo



CAM: Camel



SAN: Sand



OPTIONAL LEATHER ICON:
Look for products with this icon.



BONDED LEATHER

Options

MONTANA COLLECTION

Montana's supple contours and broken in leather look speaks to the rolling, untamed countryside and folklore of the American west. Protected with a highly abrasion resistant and stain resistant finish, Montana's durability ensures your furniture covering will stay as timeless as the wide open big skies and mountains beyond the American frontier.



SPECS



LONG LASTING



UV RESISTANT
UV RESISTANT: +650 hours
ASTM G154-QUV



TEAR RESISTANT



EASY TO CLEAN
Clean with mild soap and warm water



ABRASION RESISTANT
50,000 + DOUBLE RUB - Wyzenbeck
(Compare to most commonly used materials 15,000 double rubs)
ASTM D4157-/CFFA-1A

FACE: 100% Virgin Vinyl **BACKING:** 100% Poly-Cotton **FLAME PROTECTION:** Caf. Bulletin 117 E., UFAC/NFPA260 Class1, DIN EN 1021-1+2 - May comply with California 133 when tested with suitable components



CG: Cloud Gray



FOG: Fog



TPE: Taupe

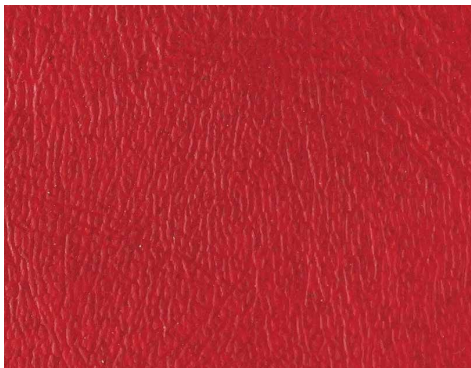

RV: Red Velvet

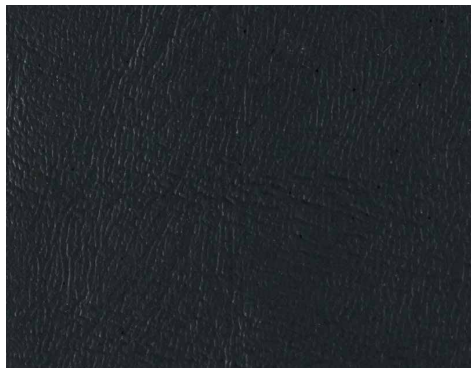

MTB: Montana Black



MADE IN THE USA



DIN EN ISO 9001, DIN EN ISO 14001, ISO/TS 16949



*prescribed by law

» **NOTE:** Actual samples are available for a truer representation of color and texture.

Amish Made
BEDROOM

COLLECTION

» COUNTRY CLASSIC COLLECTION

BEDROOM



★ IMPORTED ★
FROM
ABSOLUTELY
Nowhere

CELEBRATING * * * 30 Years

Give your space of rejuvenation and rest that timeless beauty that comes with solid hardwood furnishings. Whether it's your Master Bedroom, Guest Bedrooms or suites for your children. You can rest easy every night in the comfort and strength of fine American Craftsmanship. Design it from our wide range of color and hardware choices and make your place of retreat uniquely yours.

» MADE IN LANCASTER, PA



AMISH MADE

BEDROOM *Preview*



CRAFTSMEN | 255



FARMSTEAD | 715

-New-



HOMESTEAD | 555



MANHATTAN/LEATHER | 605D6



MANHATTAN/WOOD | 615D2



MISSION | 205LP



MISSION DELUXE | 215R6



SIMPLICITY | 455



SHAKER | 405

Bed Options

» See line drawings on following page.

» All options are available on all styles.

- New-* BH: Bookcase Headboard
- New-* AB: Wider rails to use with adjustable bases
- HB: Headboard only for motion mattress or metal frames
- LP: Low Profile Footboard
- D2: 2 Drawer Captains Footboards
- D6: 6 Drawer Platform Storage Units
- R6: Raised 6 Drawer Storage Units

BED OPTIONS *Preview*

OUR BEDS CAN ADAPT TO YOUR NEEDS

You are meticulously designed to be able to adapt to your environment, your home furnishings should to. Need more storage? Easy, choose one of the three different bed storage options. Prefer an adjustable base so your mattress adapts to your current task? Simply select the AB: rail option. We have options for every situation. Designed to adapt with you.

ORDERING

---» Simply add the abbreviation to the end of the item number.
ORDER EXAMPLE: 455D2

OPTIONS ARE AVAILABLE WITH ALL BED STYLES AND SIZES

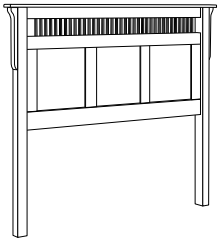

HB | Headboard Only

Choose this option for metal frames or to use with adjustable bases.

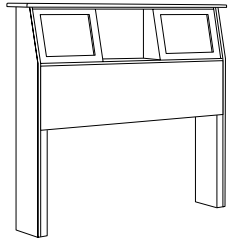

BH | Bookcase Headboard Only

Add storage and have phones, alarms, books, etc. right at your fingertips.

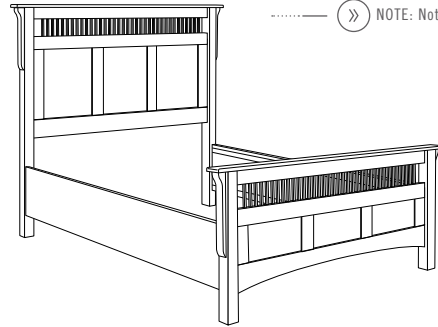

---» NOTE: Not available with LPFB'S

AB | Adjustable Base Rail Option

Wider 10" rails for increased stability and to conceal more of the base. Plus no slat brackets, so there is enough room for the adjustable base.

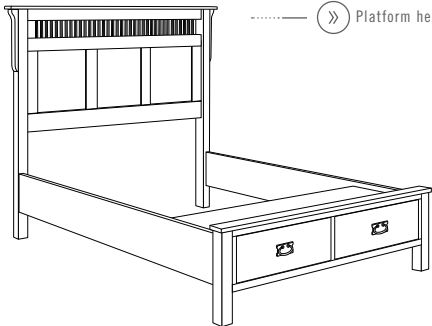

---» Platform height: 18 1/2"

New

D2 | 2 Drawer Captains Footboard

2 large drawers in the footboard are a classy way to add more storage.

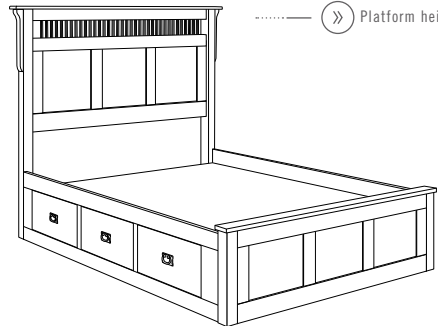

---» Platform height: 17"

New

D6 | 6 Drawer Platform Storage

With 6 large drawers, 3 each side and a hidden compartment in the center this option is the one offering you the most storage.

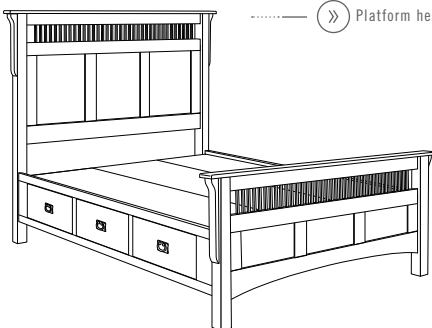

---» Platform height: 19"

R6 | Raised 6 Drawer Storage

The 6 large drawers, 3 each side are raised for better access and to allow you to store larger items beneath if desired.

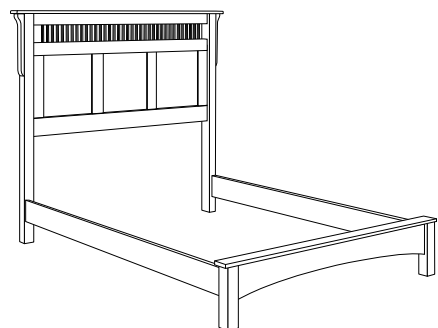

LP | Low Profile Footboard

Low footboard allows for lounging at the edge of your bed and allows the HB to be the main focus.

AMISH MADE

★ **NEW** ★
Design

BED OPTIONS

Bookcase Headboard



This attractive Headboard option is a great way to keep phones, alarms, books, and so much more right at your fingertips. Smooth sliding doors make it easy to access while the slanted face allows for comfortable reclining. Add the Power hub for easy access to power and charging outlets.

New

NOTE: Available with all styles and collections. Just add **BH** to Item number **EXAMPLE: 215BH**

11" D	11" D	11" D	11" D
67" L	60" L	82 1/2" L	44 7/8" L
44 3/4" H	44 3/4" H	44 3/4" H	44 3/4" H

SHOWN

QUEEN | FULL | KING | TWIN

» **FEATURE**

» Convenient sliding doors



» **FEATURE**

» HB is slanted for comfortable reclining

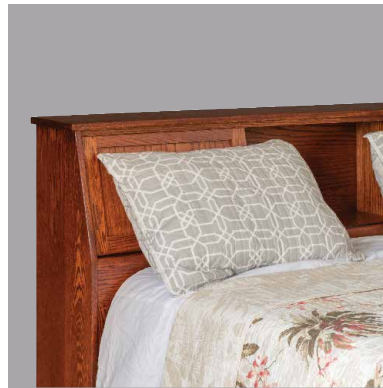

» **OPTIONAL**

» **H-L3:** Power Hub - 2 USB / 1 AC outlets

(Will be in center section unless otherwise specified.)

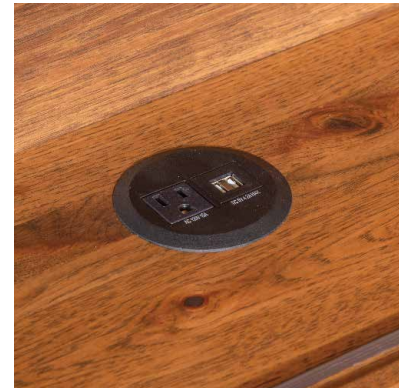

FEATURES:

- » Sliding Doors
- » Slanted for comfortable reclining
- » **OPTIONAL H-L3:** Power Hub

BOOKCASE HEADBOARD SIZES:

FULL BHF: Bookcase Headboard Only
INSIDE SIDES: 8 7/8" D x 17" L x 13 1/8" H
INSIDE CENTER: 8 7/8" D x 21 1/4" L x 13 1/8" H

KING BHK: Bookcase Headboard Only
INSIDE SIDES: 8 7/8" D x 24 1/2" L x 13 1/8" H
INSIDE CENTER: 8 7/8" D x 29" L x 13 1/8" H

TWIN BHT: Bookcase Headboard Only
INSIDE SIDES: 8 7/8" D x 12" L x 13 1/8" H
INSIDE CENTER: 8 7/8" D x 16 1/4" L x 13 1/8" H

QUEEN BHQ: Bookcase Headboard Only
INSIDE SIDES: 8 7/8" D x 19" L x 13 1/8" H
INSIDE CENTER: 8 7/8" D x 24" L x 13 1/8" H

Amish Made

CRAFTSMEN

BEDROOM

» COLLECTION



IMPORTED FROM
ABSOLUTELY
NOWHERE

The Craftsmen Collection is a series of strongly crafted pieces, designed with a contemporary flare, yet it retains the integrity of old-world craftsmanship. These attractive designs with stylish, wrought-iron pulls will be a beautiful complement to your home.

» MADE IN LANCASTER, PA

SHOWN: (118) Antique Slate on Maple Wood



AMISH MADE

BED *Options*

★ NEW ★
Design

AB: ADJUSTABLE BASE RAIL OPTION AVAILABLE FOR ALL BED STYLES

The strong and growing demand for adjustable bed bases has fueled the demand for an alternative rail system. We are happy to provide you with an improved solution. Available at the same price as a standard bed!



FEATURES

- » Solid hardwood
- » Wider - 10" rails
- » No slat brackets

BENEFITS

- » Increased stability
- » Conceals more of the adjustable base frame
- » More clearance for adjustable bases inside frame

ORDERING

Simply add AB after any bed item number.

EXAMPLE: 255AB



NOTE:

Not available with Low Profile Footboards.

AMISH MADE

CRAFTSMEN *Bedroom*

» COLLECTION



267

— SHOWN: (100) Natural on Rustic Cherry



264

— SHOWN: (100) Natural on Rustic Cherry



261 268

— SHOWN: (100) Natural on Rustic Cherry



STANDARD HARDWARE

The Craftsman Collection comes standard with the **CR-B: Craftsman Pull** a stylish wrought-iron pull.

261: Craftsman 60" Dresser

261 SIZE: 20¹/₄" D x 60" L x 34" H
SHOWN 268: Craftsman Beveled Mirror
MIRROR SIZE: 1¹/₂" D x 41¹/₄" L x 35" H
FEATURES:

- » 261 Full extension glides with 100lb capacity
- » 268 Beveled mirror

267: Craftsman Nightstand

SIZE: 20" D x 24" L x 28" H
FEATURES:
» Full extension glides

264: Craftsman Nightstand with Doors

SIZE: 18¹/₄" D x 26" L x 28" H
DOOR SPACE: 16¹/₂" D x 24" L x 12¹/₂" H
FEATURES:
» Full extension glides

» SHOWN: (TPE) Taupe Bonded Leather



253

SHOWN: (100) Natural on Rustic Cherry

» Choose from numerous bonded leather color choices. See the bonded leather page or ask for actual samples.



262 268

SHOWN: (100) Natural on Rustic Cherry

262: Craftsmen Extra Large Dresser

SIZE: 20¹/₄" D x 60" L x 43¹/₂" H
DOOR SPACE: 18¹/₄" D x 12" L x 17¹/₄" H
FEATURES:
 » Full extension glides with 100lb capacity
 » 1 adjustable shelf each side

268: Craftsmen Beveled Mirror

SIZE: 1¹/₂" D x 41¹/₄" L x 35" H
FEATURES:
 » Beveled mirror

263

SHOWN: (100) Natural on Rustic Cherry

253: Craftsmen Bench with Leather

SIZE: 16" D x 40" L x 18" H
FEATURES:
 » Available with a solid wood or bonded leather seat
 » Numerous bonded leather color choices available
 » Shown in Taupe bonded leather

263: Craftsmen Chest of Drawers

SIZE: 20¹/₄" D x 34" L x 51" H
FEATURES:
 » Full extension glides with 100lb capacity





67" D	61" D	82" D	45" D
87" L	81" L	87" L	81" L
59" H	59" H	59" H	48" H

QUEEN	FULL	KING	TWIN
255LP	256LP	257LP	258LP

BED OPTIONS

All Craftsmen Beds are available with:

Refer to Bed Options Page at the beginning of the Bedroom Section for more details.

- AB:** Wider rails for adjustable bed bases
- BH:** Bookcase headboards
- HB:** Headboard only for adjustable bases or metal frames
- LP:** Low profile footboard
- D2:** 2 drawer captains footboard
- D6:** 6 drawer platform storage unit
- *R6:** Raised 6 drawer storage unit

* Craftsmen R6 Beds come with a paneled FB - 22" high.



67" D	61" D	82" D	45" D
87" L	81" L	87" L	81" L
59" H	59" H	59" H	48" H

QUEEN	FULL	KING	TWIN
255	256	257	258

Choose from numerous bonded leather color choices. See the bonded leather page or ask for actual samples.

— SHOWN: (100) Natural on Rustic Cherry

— **TO ORDER:** Simply add the abbreviation to the end of the item number.
ORDER EXAMPLE: 455D2

— **NOTE:** Available with wood or bonded leather panels. Multiple colors to choose from. See the bonded leather page under options tab or ask for actual samples.

SHOWN 255: Craftsmen Queen Bed with Leather Panels

FOOTBOARD HEIGHT: 27" H

FEATURES:

- » Available with wood or bonded leather panels
- » Numerous bonded leather color choices available
- » Shown in Buffalo bonded leather

SHOWN 255LP: Craftsmen Queen Bed Low Profile

FOOTBOARD HEIGHT: 15½" H

FEATURES:

- » Available with wood or bonded leather panels
- » Numerous bonded leather color choices available

Amish Made
FARMSTEAD

BEDROOM

FARMSTEAD

» COLLECTION



IMPORTED FROM
ABSOLUTELY
NOWHERE

The journey begins when a young boy, his dreams and his entrepreneurial spirit start learning the trade of fine craftsmanship on his father's Farmstead. The interest grows into a passion which blossoms into years of wonderful artistry. Now over a quarter century later, this collection is designed in legacy of the enduring Farmstead where his vision was fostered.

» MADE IN LANCASTER, PA

SHOWN: (104) Seely with Antiquing on Rustic Oak



AMISH MADE

★ **NEW** ★
Design

FARMSTEAD *Bedroom*

» **COLLECTION**



» **OPTIONAL OLB:**
» Optional accent lights
» Quality LED touch lighting



BED OPTIONS

All Farmstead Beds are available with:
Refer to Bed Options Page at the beginning of the Bedroom Section for more details.

- AB:** Wider rails for adjustable bed bases
- BH:** Bookcase headboards
- HB:** Headboard only for adjustable bases or metal frames
- LP:** Low profile footboard
- D2:** 2 drawer captains footboard
- D6:** 6 drawer platform storage unit
- *R6:** Raised 6 drawer storage unit

* Farmstead R6 Beds come with a standard footboard.

71"	D	64"	D	86½"	D	49"	D
87½"	L	85½"	L	87½"	L	85½"	L
59¾"	H	59¾"	H	59¾"	H	48"	H

SHOWN QUEEN	FULL	KING	TWIN
715	716	717	718

— SHOWN: AT: Antiquing with (104) Seely on Rustic Oak



» **TO ORDER:** Simply add the abbreviation to the end of the item number.
ORDER EXAMPLE: 715D2

» **UNIQUE TO FARMSTEAD:** » Available in our **NEW RUSTIC OAK** Wood Species



764

— SHOWN: 2T: Two Tone (121) Smoke Top and (342) Country White with RG: Rubthrough on Rustic Oak with B1128-OB Hardware



NEW HARDWARE DESIGN



→ STANDARD HARDWARE ←

The Farmstead Bedroom collection comes standard with the stylish **B1128-B Belcastel 1 Pull - 128 MM C-C**



→ OPTIONAL HARDWARE ←

Optional: B1128-OB Antiqued Bronze

SHOWN 715: Farmstead Queen Bed

764: Farmstead 3 Drawer Nightstand

FOOTBOARD HEIGHT: 25"
RAIL HEIGHT: 12½"
SLAT HEIGHT: 9"
CLEARANCE BENEATH RAILS: 7¼"

FEATURES:
» **Optional OLB:** Dimmable LED accent lighting

SIZE: 19" D x 26" L x 29" H
FEATURES:
» Full extension glides with 100lb capacity

» **OPTIONAL OLM: FOR 765/768**

- » Optional accent lights
- » Quality LED touch lighting



767

— SHOWN: AT Antiquing with (104) Seely on Rustic Oak



762 | **765**

SHOWN OPTIONAL

— SHOWN: AT Antiquing with (104) Seely on Rustic Oak



762: Farmstead Mule Chest

SIZE: 21" D x 63" L x 50 1/4" H

FEATURES:

- » Full extension glides with 100lb capacity

765: Farmstead Mule Chest Mirror

SIZE: 2 1/4" D x 56 1/4" L x 23 1/2" H

FEATURES:

- » **Optional OLM:** Dimmable LED accent lighting

767: Farmstead 1 Drawer Nightstand

SIZE: 19" D x 20" L x 29" H

FEATURES:

- » Full extension glides with 100lb capacity

761 | **768**

SHOWN OPTIONAL

— SHOWN: 2T: Two Tone (121) Smoke Top and (342) Country White with RG: Rubthrough on Rustic Oak with B1128-OB Hardware



761: Farmstead 63" Dresser

SIZE: 21" D x 63" L x 34" H

FEATURES:

- » Beveled mirror with brackets for optional dresser mount

768: Farmstead Dresser Mirror

SIZE: 2 1/4" D x 48" L x 45" H

FEATURES:

- » Beveled glass
- » **Optional OLM:** Dimmable LED accent lighting

» **FEATURE**

» Attractive paneling reflects the sturdy structure of the age-old barn.



» **FEATURE**

» Graciously rounded edges
» Classy paneled drawer fronts



763

SHOWN: 2T: Two Tone (121) Smoke Top and (342) Country White with RG: Rubthrough on Rustic Oak with B1128-0B Hardware



763: Farmstead Chest of Drawers

SIZE: 21" D x 35" L x 50 1/4" H
FEATURES:

» Full extension glides with 100lb capacity



769

SHOWN: AT Antiquing with (104) Seely on Rustic Oak



769: Farmstead Chest on Chest

SIZE: 21" D x 35" L x 61 1/2" H
FEATURES:

» Full extension glides with 100lb capacity

Amish Made

HOMESTEAD

BEDROOM

» COLLECTION



HOMESTEAD

IMPORTED FROM
ABSOLUTELY
NOWHERE

Let yourself be enveloped in the inviting elements of the Homestead Bedroom. Gently arched tops extend a warm invitation that the classy arches and open spaces echo. This warmth is perfectly balanced with heavy tops and legs. Solid hardwoods speak of ageless endurance and boundless strength. Go ahead wrap yourself in the ideal feeling of coming home.

» MADE IN LANCASTER, PA

SHOWN: (110) Medium on Rustic Cherry

HOMESTEAD



HOMESTEAD BEDROOM *Collection*



AMISH MADE

HOMESTEAD *Bedroom*

» COLLECTION

LARGER PULLS



STANDARD HARDWARE

The Homestead Collection comes standard with the **ML160-B: Milan Pull** (6 1/4" C-C)



561 | 568

SHOWN: (110) Medium on Rustic Cherry



561: Homestead Triple Dresser

SIZE: 20 1/2" D x 64 3/4" L x 37 1/4" H
SHOWN 568: Optional Dresser Mirror
FEATURES:

- » Full extension glides with 100lb capacity

568: Mirror for Homestead Dresser

SIZE: 1" D x 45 1/4" L x 44" H
FEATURES:

- » Beveled mirror

564

SHOWN: (110) Medium on Rustic Cherry



564: Homestead 3 Drawer Nightstand

SIZE: 18 1/2" D x 27 1/2" L x 28 1/2" H
FEATURES:

- » Full extension glides with 100lb capacity

STANDARD FEATURES

» STANDARD FEATURES

- » 1" thick solid tops
- » Heavy legs with solid inset side panels
- » Classy arch rails



» STANDARD FEATURES

- » Curved tops create a softer inviting appeal

STANDARD FEATURES





..... SHOWN: (120) Husk on Maple

64" D	57" D	79 1/2" D	42" D
86" L	80" L	86" L	80" L
59 1/4" H	59 1/4" H	59 1/4" H	48 1/4" H
QUEEN	FULL	KING	TWIN
555LP	556LP	557LP	558LP



64" D	57" D	79 1/2" D	42" D
86" L	80" L	86" L	80" L
59 1/4" H	59 1/4" H	59 1/4" H	48 1/4" H
QUEEN	FULL	KING	TWIN
555	556	557	558

..... SHOWN: (110) Medium on Rustic Cherry

SHOWN 555: Homestead Queen Bed

SIZE: 64" D x 86" L x 59 1/4" H
FOOTBOARD HEIGHT: 26"
RAIL HEIGHT: 12 1/2"
SLAT HEIGHT: 9"
CLEARANCE BENEATH RAILS: 7 1/4"

FEATURES:

- » Available with wood or bonded leather panels
- » Bonded leather will be on HB & FB if ordered with bonded leather
- » Multiple bonded leather colors to choose from

555LP: Homestead Queen Bed w/ Low Profile FB

SIZE: 64" D x 86" L x 59 1/4" H
FOOTBOARD HEIGHT: 14"
RAIL HEIGHT: 12 1/2"
SLAT HEIGHT: 9"
CLEARANCE BENEATH RAILS: 7 1/4"

FEATURES:

- » Available with wood or bonded leather panels

BED OPTIONS

All Homestead Beds are available with:

Refer to Bed Options Page at the beginning of the Bedroom Section for more details.

- AB:** Wider rails for adjustable bed bases
- BH:** Bookcase headboards
- HB:** Headboard only for adjustable bases or metal frames
- LP:** Low profile footboard
- D2:** 2 drawer captains footboard
- D6:** 6 drawer platform storage unit
- *R6:** Raised 6 drawer storage unit

* Homestead R6 Beds come with a standard footboard.



» **TO ORDER:** Simply add the abbreviation to the end of the item number.
ORDER EXAMPLE: 455D2

» **NOTE:** Available with wood or bonded leather panels. Multiple colors to choose from. See the bonded leather page under options tab or ask for actual samples.

» **FEATURE:**

OPTIONAL BONDED LEATHER PANELS IN HB & FB





562 | 528

SHOWN: (110) Medium on Rustic Cherry



563

SHOWN: (110) Medium on Rustic Cherry



523

SHOWN: (110) Medium on Rustic Cherry

563: Homestead Chest of Drawers

SIZE: 20½" D x 36½" L x 54¾" H

FEATURES:

- » Full extension glides with 100lb capacity

528: Mirror for Homestead Mule Chest

SIZE: 1" D x 53¾" L x 22½" H

FEATURES:

- » Beveled mirror
- » Comes with optional wall mounting brackets

562: Homestead Mule Chest

SIZE: 20½" D x 64¾" L x 50¾" H

SHOWN 528: Optional Mule Mirror

FEATURES:

- » Full extension glides with 100lb capacity

523: Homestead Cheval Mirror

SIZE: 18" D x 26¾" L x 67" H

FEATURES:

- » Beveled mirror
- » Adjustable mirror



★NEW★
Design

566

SHOWN: (110) Medium on Rustic Cherry



STANDARD FEATURES

PULLOUT TRAY



★NEW★
Design

560

SHOWN: (110) Medium on Rustic Cherry



★NEW★
Design

565

SHOWN: (110) Medium on Rustic Cherry



560: Homestead Nighstand with Door

566: Homestead Master 9 Dr Dresser

565: Homestead Nightstand w/ Tray

SIZE: 18 1/4" D x 21 1/2" L x 28 1/2" H

SIZE: 20 1/2" D x 64 3/4" L x 37 1/4" H

SIZE: 18 1/4" D x 21 1/2" L x 28 1/2" H

FEATURES:

FEATURES:

OPEN SHELF: 16 3/4" D x 13" L x 5 1/2" H

- » Full extension glides with 100lb capacity

- » Full extension glides with 100lb capacity
- » **OPTIONAL 568:** Optional Dresser Mirror

- » Handy pull-out tray
- » Full extension glides with 100lb capacity



567

— SHOWN: (110) Medium on Character Cherry



569

— SHOWN: (110) Medium on Rustic Cherry



569: Homestead Chest on Chest

567: Homestead 1 Drawer Nightstand

SIZE: 20¹/₄" D x 38¹/₄" L x 61¹/₂" H

SIZE: 18¹/₂" D x 21¹/₂" L x 28¹/₂" H

FEATURES:

FEATURES:

- » Full extension glides with 100lb capacity

- » Full extension glides with 100lb capacity

Amish Made

MANHATTAN

BEDROOM

» COLLECTION



MANHATTAN

IMPORTED FROM
ABSOLUTELY
NOWHERE

The Manhattan Collection is contemporarily stylish with exceptionally clean lines. These beautifully crafted pieces are made with solid wood dovetail drawers, stylish modern pulls, and full-extension ball-bearing glides. Sharply splayed legs give it a sophisticated, yet well balanced, look. Modern Design – Old World Craftsmanship

» MADE IN LANCASTER, PA

SHOWN: (122) Cocoa on Rustic Cherry



MANHATTAN BEDROOM *Collection*

MANHATTAN



AMISH MADE

MANHATTAN *Bedroom*

» COLLECTION



639

SHOWN: (122) Cocoa on Rustic Cherry Wood with ST192-SBZ Hardware



635

SHOWN: (122) Cocoa on Rustic Cherry Wood with ST192-SBZ Hardware



» 635 FEATURE:
PULLOUT TRAY



STANDARD HARDWARE

The Manhattan Collection comes standard with the **BP-S: Contemporary Bar Pull**.

63" D	56" D	78½" D	41⅜" D
86" L	80½" L	86" L	80½" L
56¼" H	56¼" H	56¼" H	46¾" H

QUEEN **615D2** FULL **616D2** KING **617D2** TWIN/SINGLE DRAWER **611D1**

SHOWN: (122) Cocoa on Rustic Cherry Wood with ST192-SBZ Hardware



SHOWN 615D2: Manhattan Queen-Size 2-Drawer Captains Bed

639: Manhattan Chest on Chest

635: Manhattan 2 Drawer Nightstand

FOOTBOARD HEIGHT: 19"

PLATFORM HEIGHT: 18½"

CLEARANCE BENEATH RAILS: 7¼"

FEATURES:

- » 21" deep drawers with full extension drawer glides
- » Full extension glides with 100lb capacity

SIZE: 19¾" D x 33¼" L x 63½" H

FEATURES:

- » Full extension glides with 100lb capacity

SIZE: 17¾" D x 24¼" L x 28½" H

OPEN SHELF: 17¾" D x 20" L x 6¼" H

FEATURES:

- » Full extension glides with 100lb capacity
- » Handy pullout tray



631 | 638

SHOWN: SHOWN: (122) Cocoa on Rustic Cherry Wood with ST192-SBZ Hardware



614

SHOWN: (227) Rich Cherry on Maple Wood



BED OPTIONS

All Manhattan Beds are available with:

Refer to Bed Options Page at the beginning of the Bedroom Section for more details.

BH: Bookcase headboards

HB: Headboard only for adjustable bases or metal frames

D2: 2 drawer captains footboard

D6: 6 drawer platform storage unit

***R6:** Raised 6 drawer storage unit

* Manhattan R6 Beds come with solid panel FB with grooves - 22" high.

» **TO ORDER:** Simply add the abbreviation to the end of the item number.
ORDER EXAMPLE: 455D2

63" D	56" D	78½" D	41⅜" D
86" L	80½" L	86" L	80½" L
56¼" H	56¼" H	56¼" H	46¾" H

QUEEN | FULL | KING | TWIN
615 | 616 | 617 | 611

SHOWN: (227) Rich Cherry on Maple Wood

SHOWN 615: Manhattan Queen-Size Bed

631: Manhattan 61" Dresser

638: Manhattan Dresser Mirror

614: Manhattan Nightstand

FOOTBOARD HEIGHT: 14"
RAIL HEIGHT: 12½"
SLAT HEIGHT: 9"
CLEARANCE BENEATH RAILS: 7¼"
FEATURES:
» Low profile footboard

SIZE: 19¾" D x 61½" L x 34¼" H
FEATURES:
» Full extension glides with 100lb capacity

SIZE: 1¾" D x 47¼" L x 41¼" H
FEATURES:
» Beveled mirror with brackets for optional dresser mount

SIZE: 18" D x 24" L x 29" H
FEATURES:
» Full extension glides

Choose from numerous bonded leather color choices.
See the bonded leather page or ask for actual samples.



» BONDED LEATHER PANEL
» FEATURE: HIDDEN STORAGE

63" D	56" D	78½" D	41⅜" D
86" L	80½" L	86" L	80½" L
58¼" H	58¼" H	58¼" H	58¼" H

QUEEN 605D6 | FULL 606D6 | KING 607D6 | TWIN/3 DRAWER 608D3

— SHOWN: (BL) Black Leather
— SHOWN: (227) Rich Cherry on Maple Wood

SHOWN 605D6: Manhattan 6-Drawer Queen Bed with Bonded Leather Headboard

FOOTBOARD HEIGHT: 19"

PLATFORM HEIGHT: 17"

KING AND QUEEN D6 DRAWER BOX SIZE: 21½" D x 20¾" L x 9¼" H

FULL AND TWIN D6 DRAWER BOX SIZE: 21½" D x 18¾" L x 9¼" H

FEATURES:

- » Hidden center storage compartment
- » Bonded leather headboard available in numerous colors with classy nail head trim
- » Also available with drawers raised off of the floor, order as (R6)





BED OPTIONS

All Manhattan Beds are available with:
Refer to Bed Options Page at the beginning of the Bedroom Section for more details.

- BH:** Bookcase headboards
- HB:** Headboard only for adjustable bases or metal frames
- D2:** 2 drawer captains footboard
- D6:** 6 drawer platform storage unit
- *R6:** Raised 6 drawer storage unit

* Manhattan R6 Beds come with solid panel FB with grooves - 22" high.

63" D	56" D	78½" D	41⅜" D
86" L	80½" L	86" L	80½" L
58¼" H	58¼" H	58¼" H	58¼" H

QUEEN	FULL	KING	TWIN
605	606	607	608

— SHOWN: (BL) Black Leather

— SHOWN: (227) Rich Cherry on Maple Wood



— **TO ORDER:** Simply add the abbreviation to the end of the item number.
ORDER EXAMPLE: 455D2

» **BONDED**

LEATHER PANEL



63" D	56" D	78½" D	41⅜" D
86" L	80½" L	86" L	80½" L
58¼" H	58¼" H	58¼" H	58¼" H

QUEEN	FULL	KING	TWIN/SINGLE DRAWER
605D2	606D2	607D2	608D1

— SHOWN: (BL) Black Leather

— SHOWN: (227) Rich Cherry on Maple Wood



605D2: Manhattan 2 Drawer Queen Bed

605: Manhattan Queen Bed

FB HEIGHT: 19"
PLATFORM HEIGHT: 18½"
CLEARANCE BENEATH RAILS: 7¼"

FEATURES:

- » Full extension glides with 100lb capacity
- » 21" deep drawers
- » Bonded leather headboard available in numerous colors with classy nail head trim.

FB HEIGHT: 14"
RAIL HEIGHT: 12½"
SLAT HEIGHT: 9"
CLEARANCE BENEATH RAILS: 7¼"

FEATURES:

- » Bonded leather headboard available in numerous colors with classy nail head trim.



634

SHOWN: (227) Rich Cherry on Maple Wood

» OPTIONAL:

POWER PORT

Convenient, lockable slide out tops. Concealed for excellent storage of valuables or firearms. Also features **OPTIONAL** power port. Easy access for charging phones, plugging in laptops etc. Power port has 3 Standard AC outlets and 2 USB charging ports with surge protector.



» STANDARD:

LOCKING TOP



SHOWN: (227) Rich Cherry on Maple Wood

634S

634S: Man. 3 Dr Night Stand with Slideout Top

SIZE: 19³/₄" D x 26" L x 30" H

CONCEALED SPACE: 17³/₄" D x 19¹/₂" L x 2¹/₄" H

FEATURES:

- » Full extension glides with 100lb capacity
- » Convenient lockable slideout top
- » **OPTIONAL: P-32:** Power Port with 3 AC outlets and 2 USB charging ports

634: Manhattan 3-Drawer Nightstand

SIZE: 19³/₄" D x 26" L x 30" H

FEATURES:

- » Full extension glides with 100lb capacity



633

SHOWN: (227) Rich Cherry on Maple Wood



632 628

SHOWN: (227) Rich Cherry on Maple Wood

632: Manhattan 12 Drawer Mule Chest

628: Manhattan Mule Chest Mirror

633: Manhattan Chest of Drawers

SIZE: 19 3/4" D x 61 1/2" L x 50 1/2" H

FEATURES:

- » Full extension glides with 100lb capacity

SIZE: 1 1/2" D x 54 1/2" L x 18 1/2" H

FEATURES:

- » Beveled Mirror
- » Comes with optional wall mounting brackets

SIZE: 19 3/4" D x 33 1/4" L x 50 1/2" H

FEATURES:

- » Full extension glides with 100lb capacity

Amish Made
MISSION **BEDROOM**

» COLLECTION



IMPORTED FROM
ABSOLUTELY
NOWHERE

The Mission Collection reflects a style of furniture known as Mission, Arts & Crafts, Craftsman, and Quaint, introduced to America by the designer Gustav Stickley. This traditional Mission goes well with a wide range of decor tastes and will make itself at home in any bedroom.

» MADE IN LANCASTER, PA

SHOWN: (119) Cappuccino on Rustic Hickory



MISSION



AMISH MADE

MISSION *Bedroom*

» COLLECTION



214

SHOWN: (104) Seely on Rustic Hickory



STANDARD HARDWARE

The Mission Bedroom Collection comes standard with the **M-B: Classic Mission-Style Hardware.**



201 208

SHOWN: (120) Husk on Rustic Hickory



203

SHOWN: (120) Husk on Rustic Hickory



201: Mission 63" Dresser

SIZE: 20¹/₄" D x 63" L x 34" H

FEATURES:

- » Full extension glides with 100lb capacity

208: Mission Dresser Mirror

SIZE: 21¹/₂" D x 42" L x 43¹/₄" H

FEATURES:

- » Beveled mirror

214: Mission 1 Drawer Nightstand

SIZE: 21" D x 24" L x 30" H

FEATURES:

- » Full extension glides

203: Mission Chest of Drawers

SIZE: 20¹/₄" D x 33³/₄" L x 48³/₄" H

FEATURES:

- » Full extension glides with 100lb capacity



204

SHOWN: (120) Husk on Rustic Hickory



130

SHOWN: (116) Harvest on Red Oak



» Choose from numerous bonded leather color choices. See the bonded leather page or ask for actual samples.



OPTIONAL:

POWER PORT

Convenient, lockable slide out tops. Concealed for excellent storage of valuables or firearms. Also features **OPTIONAL** power port. Easy access for charging phones, plugging in laptops etc. Power port has 3 Standard AC outlets and 2 USB charging ports with surge protector.



STANDARD:

LOCKING TOP



204S

204S: Mission 3-Drawer Nightstand

SIZE: 18¹/₄" D x 24³/₄" L x 28³/₄" H

CONCEALED SPACE:
15³/₄" D x 16" L x 2¹/₄" H

FEATURES:

- » Full extension glides with 100lb capacity
- » Convenient lockable slideout top
- » **OPTIONAL: P-32: Power Port** - with 3 AC outlets and 2 USB charging ports

204: Mission 3-Drawer Nightstand

SIZE: 18¹/₄" D x 24³/₄" L x 27¹/₂" H

FEATURES:

- » Full extension glides with 100lb capacity

130: Mission Rocker

SIZE: 31" D x 23¹/₂" L x 41³/₄" H

FEATURES:

- » Comfortable lumbar back
- » Available with wood or bonded leather seat
- » Numerous bonded leather color choices available



202 | 208 — SHOWN: (104) Seely on Rustic Hickory

ALL NEW BED STEPS – Introduced by popular request!

These are great for easier access into platform beds or beds with higher mattresses. They also work perfectly for pets to access sofas, chairs or beds.

**NEW*
Design*

⊗ FEATURE:
ANTI-SLIP TAPE



Optional Anti-slip tape included that can be put on tread if desired.



212 — SHOWN: 2T Natural top with (119) Cappuccino base on Rustic Hickory

**NEW*
Design*

⊗ 225 FEATURE:
PULLOUT TRAY



225 — SHOWN: (119) Cappacino on Rustic Hickory



225: Mission 2 Drawer Nightstand

SIZE: 18¹/₄" D x 24³/₄" L x 27³/₄" H
OPEN SHELF: 18¹/₄" D x 18¹/₂" L x 4³/₄" H
FEATURES:
» Handy pull-out tray
» Full extension glides

202: Mission 48" Dresser

SIZE: 20¹/₄" D x 48" L x 34" H
FEATURES:
» Full extension glides with 100lb capacity

208: Mission Dresser Mirror

SIZE: 2¹/₂" D x 42" L x 43¹/₄" H
FEATURES:
» Beveled glass

212: Bed Steps 22" Wide

SIZE: 19¹/₄" D x 22" L x 15" H
TREAD SPECS: 10" D x 7" H
FEATURES:
» Anti-slip tape included that can be put on tread if desired
» Standard tread height an depth for safety
» Sturdy, Solid wood base reinforced with braces



68" D	61" D	83 1/2" D	45 7/8" D
87" L	81 1/2" L	87" L	81 1/2" L
59 3/4" H	59 3/4" H	59 3/4" H	49" H

QUEEN	FULL	KING	TWIN
215	216	217	218

— SHOWN: (119) Cappuccino on Rustic Hickory



BED OPTIONS

All Mission beds are available with:

Refer to Bed Options Page at the beginning of the Bedroom section for more details.

AB: Wider rails for Adjustable bed bases
BH: Bookcase Headboards
HB: Headboard only for adjustable bases or metal frames

LP: Low Profile Footboard
D2: 2 Drawer Captains Footboard
D6: 6 Drawer Platform Storage unit
***R6:** Raised 6 Drawer Storage unit

* Deluxe Mission R6 beds come with a standard Footboard.

— **TO ORDER:** Simply add the abbreviation to the end of the item number.
ORDER EXAMPLE: 455D2

— **NOTE:** Available with wood or bonded leather panels. Multiple colors to choose from. See the bonded leather page under options tab or ask for actual samples.

— **NOTE:** Leather only available on Deluxe Mission beds.
(215-216-217-218)



68" D	61" D	83 1/2" D	45 7/8" D
87" L	81 1/2" L	87" L	81 1/2" L
59 3/4" H	59 3/4" H	59 3/4" H	49" H

QUEEN	FULL	KING	TWIN / SINGLE DRAWER
215D2	216D2	217D2	218D1

— (119) Cappuccino on Rustic Hickory



SHOWN 216D2: Deluxe Full-Size Captains Bed

FOOTBOARD HEIGHT: 19"
PLATFORM HEIGHT: 18 1/2"
CLEARANCE BENEATH RAILS: 7 1/4"

FEATURES:

» Full extension glides with 100lb capacity

SHOWN 215: Deluxe Mission Queen-Size Bed

FOOTBOARD HEIGHT: 27"
RAIL HEIGHT: 12 1/2"
SLAT HEIGHT: 9"
CLEARANCE BENEATH RAILS: 7 1/4"



FEATURE: **LARGE STORAGE DRAWERS**

68" D	61" D	83 ¹ / ₂ " D	45 ⁷ / ₈ " D
87" L	81 ¹ / ₂ " L	87" L	81 ¹ / ₂ " L
59 ³ / ₄ " H	59 ³ / ₄ " H	59 ³ / ₄ " H	49" H

QUEEN	FULL	KING	TWIN / 3 DRAWER
215R6	216R6	217R6	218R3

— SHOWN: (119) Cappuccino on Rustic Hickory



FEATURE: **HIDDEN STORAGE**

68" D	61" D	83 ¹ / ₂ " D	45 ⁷ / ₈ " D
87" L	81 ¹ / ₂ " L	87" L	81 ¹ / ₂ " L
59 ³ / ₄ " H	59 ³ / ₄ " H	59 ³ / ₄ " H	49" H

QUEEN	FULL	KING	TWIN / 3 DRAWER
215D6	216D6	217D6	218D3

— SHOWN: (119) Cappuccino on Rustic Hickory



SHOWN 215D6: Deluxe Mission Queen 6-Drawer Platform Bed

(D6) FOOTBOARD HEIGHT: 19"

(D6) PLATFORM HEIGHT: 17"

KING AND QUEEN D6 DRAWER BOX SIZE: 21¹/₂" D x 20³/₄" L x 9¹/₄" H

FULL AND TWIN D6 DRAWER BOX SIZE: 21" D x 18³/₄" L x 9¹/₄" H

FEATURES:

- » Hidden center storage compartment
- » Full extension glides with 100lb capacity

SHOWN 215R6: Deluxe Mission Raised 6-Drawer Bed

RAISED PLATFORM HEIGHT: 19"

CLEARANCE BENEATH RAILS: 6¹/₄"

KING AND QUEEN D6 DRAWER BOX SIZE: 21" D x 20³/₄" L x 6¹/₂" H

FULL AND TWIN D6 DRAWER BOX SIZE: 21" D x 18³/₄" L x 6¹/₂" H

FEATURES:

- » Six-raised large storage drawers
- » Full extension glides with 100lb capacity



68" D	61" D	83½" D	45⅞" D
87" L	81½" L	87" L	81½" L
55" H	55" H	55" H	46½" H

QUEEN	FULL	KING	TWIN
205	206	207	211

SHOWN: (104) Seely on Rustic Hickory

BED OPTIONS

All Mission beds are available with:

Refer to Bed Options Page at the beginning of the Bedroom section for more details.

AB: Wider rails for Adjustable bed bases

BH: Bookcase Headboards

HB: Headboard only for adjustable bases or metal frames

LP: Low Profile Footboard

D2: 2 Drawer Captains Footboard

D6: 6 Drawer Platform Storage unit

* **R6:** Raised 6 Drawer Storage unit

* Regular Mission R6 beds come with a paneled FB 22" high.

Ⓢ **TO ORDER:** Simply add the abbreviation to the end of the item number.
ORDER EXAMPLE: 455D2



68" D	61" D	83½" D	45⅞" D
87" L	81½" L	87" L	81½" L
55" H	55" H	55" H	46½" H

QUEEN	FULL	KING	TWIN
205LP	206LP	207LP	211LP

SHOWN: (116) Harvest on Red Oak

SHOWN 205LP: Mission Queen-Size Bed with Low-Profile Footboard

FOOTBOARD HEIGHT: 14"

RAIL HEIGHT: 12½"

SLAT HEIGHT: 9"

CLEARANCE BENEATH RAILS: 7¼"

SHOWN 205: Mission Queen Size Bed

FOOTBOARD HEIGHT: 27"

RAIL HEIGHT: 12½"

SLAT HEIGHT: 9"

CLEARANCE BENEATH RAILS: 7¼"



221 | 228

SHOWN: (119) Cappuccino on Rustic Hickory



223

SHOWN: (119) Cappuccino on Rustic Hickory

223: Mission Cheval Mirror

SIZE: 18" D x 26³/₄" L x 67" H

FEATURES:

- » Beveled mirror
- » Mirror rotates

221: Mission Mule Chest

SIZE: 20¹/₄" D x 63" L x 50¹/₄" H

FEATURES:

- » Full extension glides with 100lb capacity



219

SHOWN: (119) Cappuccino on Rustic Hickory

228: Optional Mule Mirror

SIZE: 2¹/₂" D x 58" L x 18¹/₄" H

FEATURES:

- » Beveled mirror
- » Comes with optional wall mounting brackets

219: Mission Chest on Chest

SIZE: 21¹/₄" D x 35³/₄" L x 60¹/₄" H

FEATURES:

- » Full extension glides with 100lb capacity



210

SHOWN: (119) Cappuccino on Rustic Hickory



209

SHOWN: (119) Cappuccino on Rustic Hickory

209: Mission Lingerie Chest

SIZE: 18¹/₄" D x 24³/₄" L x 49¹/₂" H

FEATURES:

- » Full extension glides with 100lb capacity

210: Mission Armoire/Ent. Center

SIZE: 21¹/₄" D x 36" L x 72¹/₂" H

DOOR SPACE: 18" D x 30¹/₂" L x 39³/₄" H

FEATURES:

- » Full extension glides with 100lb capacity
- » 2 adjustable shelves and wooden clothes rod



BED OPTIONS

All Shaker beds are available with:

Refer to Bed Options Page at the beginning of the Bedroom section for more details.

- AB:** Wider rails for Adjustable bed bases
- BH:** Bookcase Headboards
- HB:** Headboard only for adjustable bases or metal frames
- LP:** Low Profile Footboard
- D2:** 2 Drawer Captains Footboard
- D6:** 6 Drawer Platform Storage unit
- ***R6:** Raised 6 Drawer Storage unit

* Shaker R6 beds come with a standard Footboard.

» **TO ORDER:** Simply add the abbreviation to the end of the item number.
ORDER EXAMPLE: 455D2

» **NOTE:** Available with wood or bonded leather panels. Multiple colors to choose from. See the bonded leather page under options tab or ask for actual samples.



64½" D	57½" D	80" D	42¾" D
87" L	81½" L	87" L	81½" L
55¼" H	55¼" H	55¼" H	46¾" H

QUEEN	FULL	KING	TWIN
405	406	407	411

— SHOWN: (104) Seely on Rustic Hickory



— SHOWN: (112) Provincial on Red Oak

202 408

» Shown with WK knobs



— SHOWN: (112) Provincial on Red Oak

203

» Shown with WK knobs



202: 48" Dresser

SIZE: 20¼" D x 48" L x 34" H

FEATURES:

- » Full extension glides with 100lb capacity
- » Order with (WK) wooden knobs

408: Shaker Mirror

SIZE: 2½" D x 42" L x 36½" H

FEATURES:

- » Beveled mirror

SHOWN 406: Shaker Full-Size Bed

FOOTBOARD HEIGHT: 27"

RAIL HEIGHT: 12½"

SLAT HEIGHT: 9"

CLEARANCE BENEATH RAILS: 7¼"

203: Chest of Drawers

SIZE: 20¼" D x 33¾" L x 48¾" H

FEATURES:

- » Full extension glides with 100lb capacity
- » Order with (WK) wooden knobs

Amish Made
SIMPLICITY **BEDROOM**

» COLLECTION



IMPORTED FROM
ABSOLUTELY
NOWHERE

Meet nostalgia with a modern flare. Welcome to the Simplicity collection. A simplistic design that takes its cues from the Shaker era but with a decidedly modern edge. Reverse beveled tops, tapered legs and slight arches create a cultured appeal without getting complex. Its simplicity mastered.

» MADE IN LANCASTER, PA

SHOWN: (104) Seely on Maple Wood



SIMPLICITY BEDROOM *Collection*



SIMPLICITY

AMISH MADE

★ NEW ★
Design

SIMPLICITY *Bedroom*

» COLLECTION



63½" D	56½" D	79" D	41¾" D
87" L	81½" L	87" L	44⅞" L
54" H	54" H	54" H	54" H

SHOWN QUEEN	FULL	KING	TWIN
455	456	457	458

— SHOWN: (119) Cappuccino on Rustic Hickory



BED OPTIONS

All Simplicity beds are available with:
Refer to Bed Options Page at the beginning of the Bedroom section for more details.

- AB: Wider rails for Adjustable bed bases
- BH: Bookcase Headboards
- HB: Headboard only for adjustable bases or metal frames
- LP: Low Profile Footboard
- D2: 2 Drawer Captains Footboard
- D6: 6 Drawer Platform Storage unit
- *R6: Raised 6 Drawer Storage unit

* Simplicity R6 beds come with a standard Footboard.

» TO ORDER: Simply add the abbreviation to the end of the item number.
ORDER EXAMPLE: 455D2

» NOTE: Available with wood or bonded leather panels. Multiple colors to choose from. See the bonded leather page under options tab or ask for actual samples.



464

SHOWN: 2T Natural top with (119) Cappuccino base on Rustic Hickory



LARGER PULLS



STANDARD HARDWARE

The Simplicity Bedroom collection comes standard with the stylish LY128-OB Leyton Pull

464: Simplicity 3 Drawer Nightstand

SIZE: 19⅞" D x 22¼" L x 28" H

FEATURES:

- » Full extension glides with 100lb capacity

SHOWN 455: Simplicity Queen Bed

FOOTBOARD HEIGHT: 26" H

FEATURES:

- » Available with wood or bonded leather panels
- » Multiple bonded leather colors to choose from

STANDARD
FEATURES



» Reverse beveled tops add a sense of refinement



» Tapered legs and slightly arched sides complete the cultured appeal



» Stylish hardware with a contemporary flare



466 | OPTIONAL **468**

SHOWN: 2T Natural top with (119) Cappuccino base on Rustic Hickory



466: Simplicity Dresser

468: Simplicity Dresser Mirror

SIZE: 19⁷/₈" D x 48" L x 34¹/₂" H
SHOWN 568: Optional Dresser Mirror

FEATURES:
» Full extension glides with 100lb capacity

SIZE: 2" D x 39⁵/₈" L x 33⁷/₈" H
FEATURES:
» Beveled mirror



463

SHOWN: 2T Natural top with (119) Cappuccino base on Rustic Hickory



463: Simplicity Chest of Drawers

SIZE: 19⁷/₈" D x 30¹/₄" L x 51¹/₂" H
FEATURES:
» Full extension glides with 100lb capacity



NEW
Design

461 | OPTIONAL **468** | ——— SHOWN: (104) Seely on Maple



NEW
Design

462 | OPTIONAL **465** | ——— SHOWN: (104) Seely on Maple



462: Simplicity Mule Chest

SIZE: 19⁷/₈" D x 64" L x 52¹/₂" H

SHOWN 465: Optional Mule Chest Mirror

FEATURES:

- » Full extension glides with 100lb capacity

465: Simplicity Mule Chest Mirror

SIZE: 2" D x 56¹/₄" L x 17¹/₂" H

FEATURES:

- » Beveled Mirror

461: Simplicity Large 6 Drawer Dresser

SIZE: 19⁷/₈" D x 64" L x 36" H

SHOWN 468: Optional Dresser Mirror

FEATURES:

- » Full extension glides with 100lb capacity

468: Simplicity Dresser Mirror

SIZE: 2" D x 39⁵/₈" L x 33⁷/₈" H

FEATURES:

- » Beveled mirror

NEW
Design

467

SHOWN: (104) Seely on Maple



NEW
Design

469

SHOWN: (104) Seely on Maple



469: Simplicity Chest on Chest

SIZE: 19⁷/₈" D x 37³/₄" L x 62" H

FEATURES:

- » Full extension glides with 100lb capacity

467: Simplicity 1 Drawer Nightstand

SIZE: 19⁷/₈" D x 20" L x 29" H

FEATURES:

- » Full extension glides with 100lb capacity

Amish Made
DINING

COLLECTION

» COUNTRY CLASSIC COLLECTION



★ IMPORTED ★
FROM
ABSOLUTELY
Nowhere

CELEBRATING *** *30* Years

How many memories are made and shared around the Dining table? Furnish your family with a dining suite that will become a part of those remembrances and be treasured for generations. Choose a suite that is built with solid American hardwoods, gear driven slides and passionate integrity. Your family deserves it. This is one dining selection that may last as long as your memories.

» MADE IN LANCASTER, PA

DINING

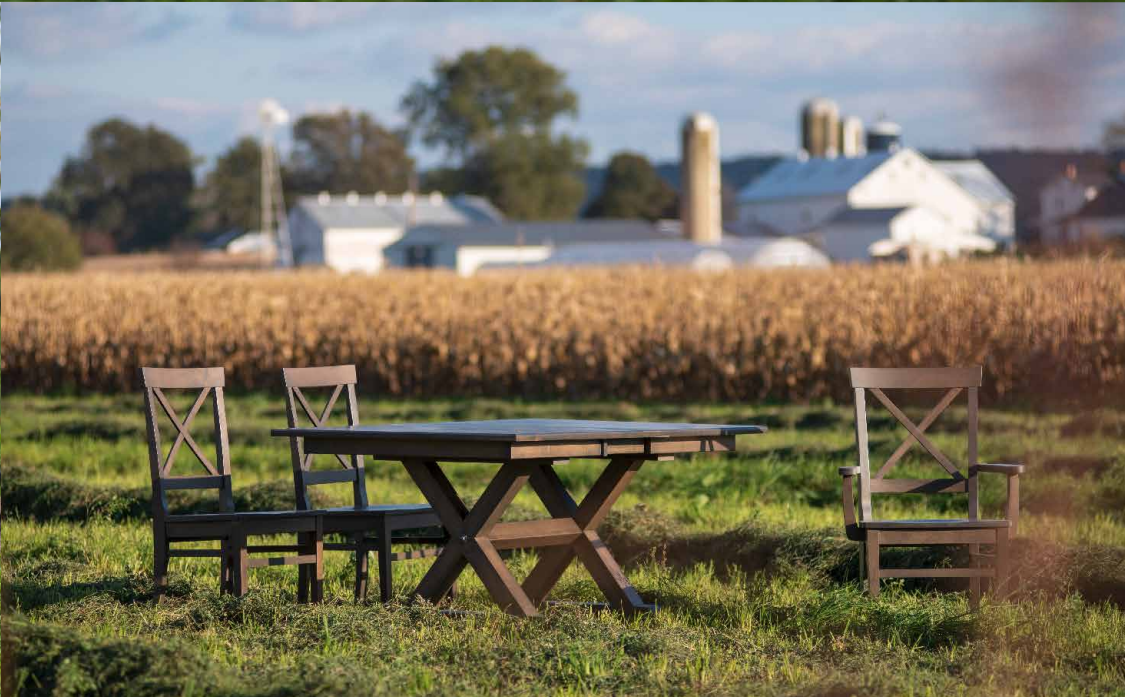

CUSTOMIZABLE DINING TABLE *Program*



DESIGN A TABLE YOUR WAY

» JUST FOLLOW THESE STEPS



1. CHOOSE TOP SIZE

DT3648	36 x 48
DT3660	36 x 60
DT4248	42 x 48
DT4260	42 x 60
DT4272	42 x 72
DT4860	48 x 60
DT4872	48 x 72

2. CHOOSE SELF STORING LEAF OPTIONS

0	No leaves* <small>* NOTE: Solid Top = Grain running length wise.</small>
1	1 – 12" Self-storing leaf
2	2 – 12" Self-storing leaves

3. CHOOSE EDGE PROFILE:

SR – Standard 3/8" Roundover



CH – 3/8" Chamfer



BV – 1" Bevel



4. CHOOSE LEG OPTIONS

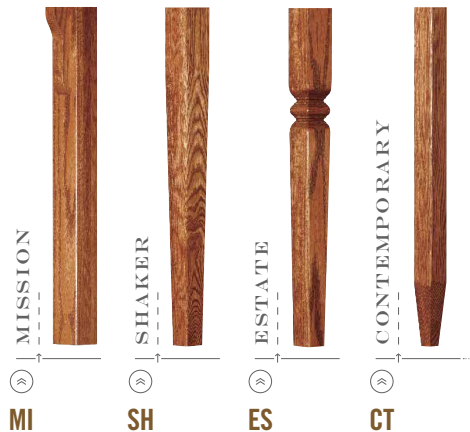

8 | HARDWOOD CHOICES

30+ | COLOR CHOICES

SEE YOUR SALES ASSOCIATE FOR YOUR FULL RANGE OF OPTIONS.

5. UNIQUELY YOURS



ORDER EXAMPLE

If you would like a Dining Table 42" wide by 60" long with 2 self-storing leaves, a beveled edge and Mission style legs, you would order like this:

DT4260 — 2 — BV — MI = DT4260-2- BV-MI
TOP LEAF EDGE LEGS ITEM NUMBER

AMISH MADE

DINING *Preview*



FARMSTEAD | 484 *-New-*



MISSION | 0820



MISSION | 085



(MISSION TAB)
SHAKER | 049



MISSION | 086



(MISSION TAB)
TRANSITIONAL | 158



MONARCH | 885



(MISSION TAB)
MANHATTAN | 637



(MISSION TAB)
MANHATTAN | 636



DT: Customizable Table Program *-New-*

AMISH MADE

DINING *Preview*

CHAIRS



051 |



052 |



133 |



134 |



131 |



132 |



130 |



135 |

MISSION

CHAIRS



151 |



152 |



101 |



481 |



482 |



881 |



882 |



156 |

MISSION

FARMSTEAD

MONARCH

MANHATTAN

STOOLS



293 |



295 |



623 |



625 |



624 |



626 |



493 |



495 |

MISSION

MANHATTAN

FARMSTEAD

BENCHES



003 |



004 |



005 |



173 |



174 |



175 |



473 |



474 |



475 |

MISSION

FARMSTEAD

BENCHES



253 |



813 |

CRAFTSMEN

MONARCH

Amish Made
CROSSWAY

DINING

» COLLECTION



IMPORTED FROM
ABSOLUTELY
NOWHERE

Crossway speaks of new roads, new choices. Go ahead take the road less traveled, revel in this tasteful design with fashionable soft-close door hardware and softly eased corners. Discover the difference of modern taste that remains warm & inviting. It's a journey worth taking.

» MADE IN LANCASTER, PA



AMISH MADE

CROSSWAY Dining

★ NEW ★
Design

» COLLECTION

» ALSO AVAILABLE: 785: 72" L Table

» 783/785 FEATURE:
» Self-storing Leaves

» 783/785 FEATURE:
» Classy base design

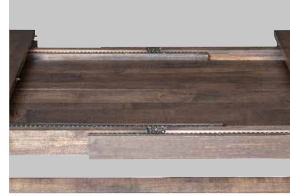

→ STANDARD HARDWARE ←



The Crossway Dining Collection comes standard with the **ML-BK: Milan Knob**.

783

SHOWN: (121) Smoke on Maple Wood



781

SHOWN: (121) Smoke on Maple Wood

781: Crossway side chair

SIZE: 19" D x 21" L x 38½" H



782

SHOWN: (121) Smoke on Maple Wood

785: Crossway 72" Extension Table

SIZE: 42" D x 72" L x 30" H

FEATURES:

- » Extends: 120" L with 4-12" leaves
- » 4 self-storing leaves
- » 1" thick top

783: Crossway 52" Extension Table

SIZE: 42" D x 52" L x 30" H

ALSO AVAILABLE: 785: 72" L table with 4-self storing leaves

FEATURES:

- » Extends: 76" L with 2-12" leaves
- » 2 self-storing leaves
- » 1" thick top

782: Crossway Arm Chair

SIZE: 26¼" D x 26¼" L x 38½" H

THE CLASSY CROSSWAY COLLECTION IS AVAILABLE
WITH YOUR CHOICE OF 2 UNIQUE DOOR STYLES.

CHOOSE FROM SOFT CLOSE HINGED
DOORS OR SOFT CLOSE SLIDING DOORS

- 1 CONCEALED SOFT CLOSE HINGES (STANDARD):
This quality soft close hinge is standard on all items.



STANDARD
FEATURE



- 2 SOFT CLOSE SLIDING DOORS (OPTIONAL):
This attractive upgrade creates a unique look. It is designed with
an innovative soft close catch that gently pulls your doors to a fully
closed position. Just add **SD** to the item number. EXAMPLE: 787SD



OPTIONAL
FEATURE

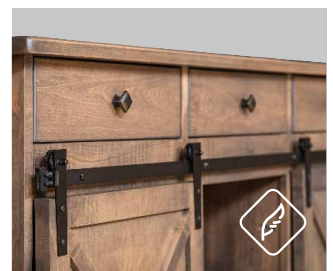

» Just add **SD** to the item number.
EXAMPLE: 787SD



773: 3'
774: 4'
775: 5'

» Also available with a bonded leather seat.
See the bonded leather page or ask for actual samples.

775

———— SHOWN: (121) Smoke on Maple Wood



**OPTIONAL
FEATURE**



» Optional mirror accents your décor

**STANDARD
FEATURE**



» Goblet racks both sides



» Also comes with adjustable shelf
for center compartment



STANDARD

SHOWN OPTIONAL

OPTIONAL

780

780SD

788

———— SHOWN: (121) Smoke on Maple Wood

780: Crossway Server with Wine Rack

788: Crossway Server Mirror / Brackets

775: Crossway 5' Bench

SIZE: 21" D x 60" L x 34³/₄" H
INSIDE DOORS: 17³/₄" D x 17¹/₂" L x 20³/₄" H
(19³/₄" H with Goblet Rack Inside)
ALSO AVAILABLE: 780SD: Sliding Doors
FEATURES:

- » Soft close doors and drawers
- » 1 adjustable shelf each side
- » 1 adjustable shelf center
- » Full extension glides – 100lb capacity
- » 1" thick top

SIZE: 1" D x 55³/₄" L x 19¹/₄" H
BRACKETS: 8³/₄" D x 1¹/₄" L x 8³/₄" H
FEATURES:

- » Beveled mirror

SIZE: 15¹/₄" D x 60" L x 18" H
ALSO AVAILABLE: 773: 3' / 774: 4'



SHOWN STANDARD

OPTIONAL

787B

787BSD

— SHOWN: (121) Smoke on Maple Wood



STANDARD

SHOWN OPTIONAL

787

787SD



» Also available china with wine rack and glass doors: **787W / 787WSD**

— SHOWN: (121) Smoke on Maple Wood



787: Crossway Large China

SIZE: 21" D x 60" L x 82³/₄" H

INSIDE TOP: 12³/₄" D x 55" L x 29" H

OPENING BENEATH TOP DOORS: 14³/₄" H

INSIDE BASE: 17³/₄" D x 17¹/₂" L x 20³/₄" H

ALSO AVAILABLE: 787SD: Sliding Doors

ALSO AVAILABLE 787W / 787WSD:

With wine and goblet racks and glass doors

FEATURES:

- » Soft close doors and drawers
- » 2 adjustable glass shelves in top
- » 1 adjustable shelf each side and center in base
- » Full extension glides
- » – 100lb capacity
- » 1" thick top
- » LED Touch Lighting

787B: Crossway Buffet

SIZE: 21" D x 60" L x 34³/₄" H

INSIDE TOP: 17³/₄" D x 17¹/₂" L x 20³/₄" H

ALSO AVAILABLE: 787BSD: Sliding Doors

FEATURES:

- » Soft close doors and drawers
- » 1 adjustable shelf each side and center
- » Full extension glides – 100lb capacity
- » 1" thick top

Amish Made
FARMSTEAD

DINING

» **COLLECTION**

FARMSTEAD



IMPORTED FROM
ABSOLUTELY
NOWHERE

Reminiscent of Grandma's olde country kitchen but with a Transitional flare that blends yesterday's memories with today's styles. Heavy frame construction and plank grooved tops reflect the strength and design with which our olde Famstead was built by our forefathers. Built to last, crafted for generations.

» MADE IN LANCASTER, PA

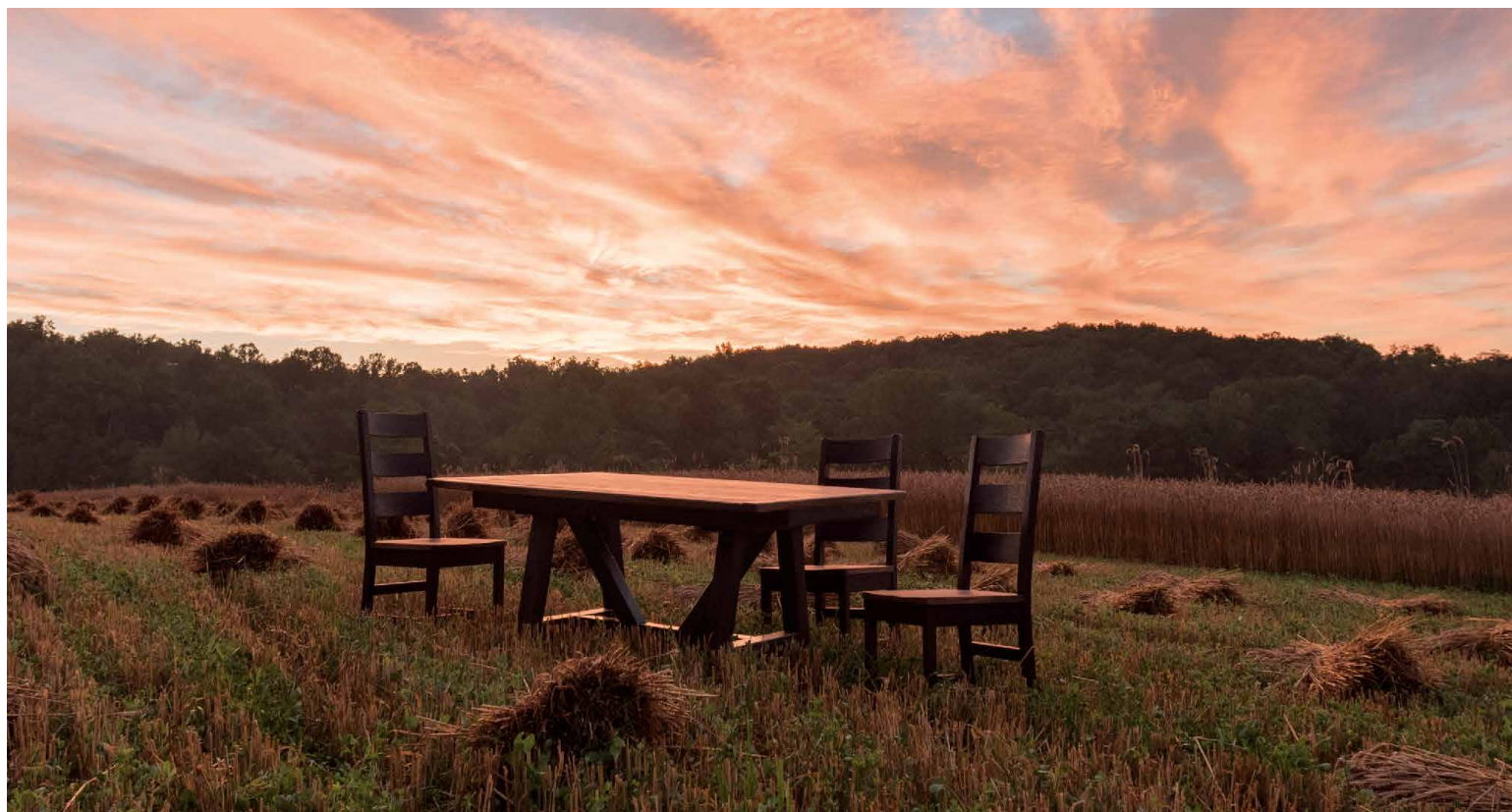

AMISH MADE

OLDE FARMSTEAD

Dining

COLLECTION

» OPTION:

» 485: 42" x 66" standard table with 4-12" self storing leaves

» STANDARD FEATURE:

PLANK GROOVED TOPS



» FEATURE:

484 COMPANY BOARDS



STANDARD HARDWARE

The Farmstead Dining Collection comes standard with the **WK: Wooden Knob.**



» Extends to 104" with 2-16" company boards » 2" thick top edge on 484/485

484

SHOWN: 2T River Rock Tops with Dark Knight Bases on Red Oak

» FEATURE:

481-482
ROUGH SAWN
BACK AND LEGS



481

SHOWN: 2T River Rock Tops with Dark Knight Bases on Red Oak



482

SHOWN: 2T River Rock Tops with Dark Knight Bases on Red Oak



481: Farmstead Side Chair

SIZE: 18½" D x 18½" L x 41" H

FEATURES:

- » Available with wood or bonded leather seats
- » 10 bonded leather color choices available
- » Rough sawn back and back legs

484: Farmstead Table

SIZE: 42" D x 72" L x 30" H

ALSO AVAILABLE: 485: Regular extension table w/4-12" self storing leaves

SHOWN: 481/482: Chairs

FEATURES:

- » 2-16" Company Boards
- » 1½" thick top edge
- » Plank grooved top

482: Farmstead Arm Chair

SIZE: 18½" D x 25½" L x 41" H

FEATURES:

- » Wide comfortably curved back
- » Available with wood or bonded leather seats
- » 10 bonded leather color choices available
- » Rough Sawn back and back legs

» FEATURE:

490 ISLAND TOP OPTIONS

- BB3060:** 30x60 1½" Butcher Block Island Top
- BB3652:** 36x52 1½" Butcher Block Island Top
- BB3660:** 36x60 1½" Butcher Block Island Top
- PR3060:** 30x60 Plank Groove 1" Regular Island Top
- PR3652:** 36x52 Plank Groove 1" Regular Island Top
- PR3660:** 36x60 Plank Groove 1" Regular Island Top
- P2T3060:** 30x60 Plank Groove 1½" Double thick edge Island Top
- P2T3652:** 30x52 Plank Groove 1½" Double thick edge Island Top
- P2T3660:** 36x60 Plank Groove 1½" Double thick edge Island Top

NOTE: If you would like to order without Plank groove remove the P from item number.

» FEATURE:

490 PANELED AND FINISHED BACK



490

SHOWN: 2T River Rock Tops with Dark Knight Bases on Red Oak

» SHOWN: (TPE) Taupe Leather

» SHOWN: (FOG) Fog Leather

» SHOWN: (CHO) Chocolate Leather » ALSO AVAILABLE: 24" & 30" HEIGHTS



493

SHOWN: River Rock on Red Oak

495

SHOWN: River Rock on Red Oak

474

473

475

SHOWN: River Rock on Red Oak

493: Farmstead 24" Bar Stools

SIZE: 14" D x 16" L x 24" H

FEATURES:

- » Wood seat has 1½" thick top edge
- » Available with wood or bonded leather seats
- » 10 bonded leather color choices available

490: Farmstead Island Base

SIZE: 25" D x 47" L x 34½" H

FEATURES:

- » Numerous top choices. See Top Options List
- » 1 adjustable wood shelf in base
- » Full extension glides with 100lb capacity

495: Farmstead 30" Bar Stools

SIZE: 17" D x 16" L x 30" H

FEATURES:

- » Wood seat has 1½" thick top edge
- » Available with wood or bonded leather seats
- » 10 bonded leather color choices available

474: Farmstead 4' Farm Bench

SIZE: 16" D x 48" L x 18" H

ALSO AVAILABLE: 473: 3' 475: 5' 24" & 30" heights

FEATURES:

- » Wood seat has 1½" thick top edge
- » Available with wood or bonded leather seats
- » 10 bonded leather color choices available



297

FEATURE:  SIDE TOWEL RACK



 FEATURE: CLASSY METAL ACCENTS



298

298: Transitional 52" Butler

SIZE: 20" D x 52" L x 36" H

FIXED SHELVES:

16¹/₄" D x 29¹/₄" L x 12¹/₄" H

FEATURES:

- » 1¹/₂" thick top edge
- » Portable with smooth swivel castors
- » Convenient towel rack on side
- » Classy metal rods
- » Full extension slides

297: Transitional 36" Butler

SIZE: 20" D x 36" L x 36" H

FIXED SHELVES:

16¹/₄" D x 29¹/₄" L x 12¹/₄" H

FEATURES:

- » 1¹/₂" thick top edge
- » Portable with smooth swivel castors
- » Convenient towel rack on side
- » Classy metal rods
- » Full extension slides

Amish Made
MISSION

DINING

» **COLLECTION**



IMPORTED FROM
ABSOLUTELY
NOWHERE

The Mission Collection reflects a style of furniture known as Mission, Arts & Crafts, Craftsman, and Quaint, introduced to America by the designer Gustav Stickley. This traditional Mission line brings the heritage of strong family values and the beauty of American hardwoods into the conversation center of your home.

» MADE IN LANCASTER, PA

SHOWN: (104) Seely on Maple Wood

MISSION



AMISH MADE

MISSION *Dining*

» COLLECTION



STANDARD HARDWARE

The Mission Dining Collection comes standard with the **M-B: Classic Mission-Style Hardware**.

» FEATURE:

2" DOUBLE THICK TOP EDGE



085

SHOWN: 2T (119) Cappuccino Top with (348) Chelsea Grey Base on Red Oak



085: Mission Large Extension Table

SIZE: 42" D x 66" L x 30" H

SHOWN 131/132: Madison Chairs

FEATURES:

- » Extends to 42" D x 114" L with four 12" boards
- » Self-storing leaves
- » 2" double thick top edge

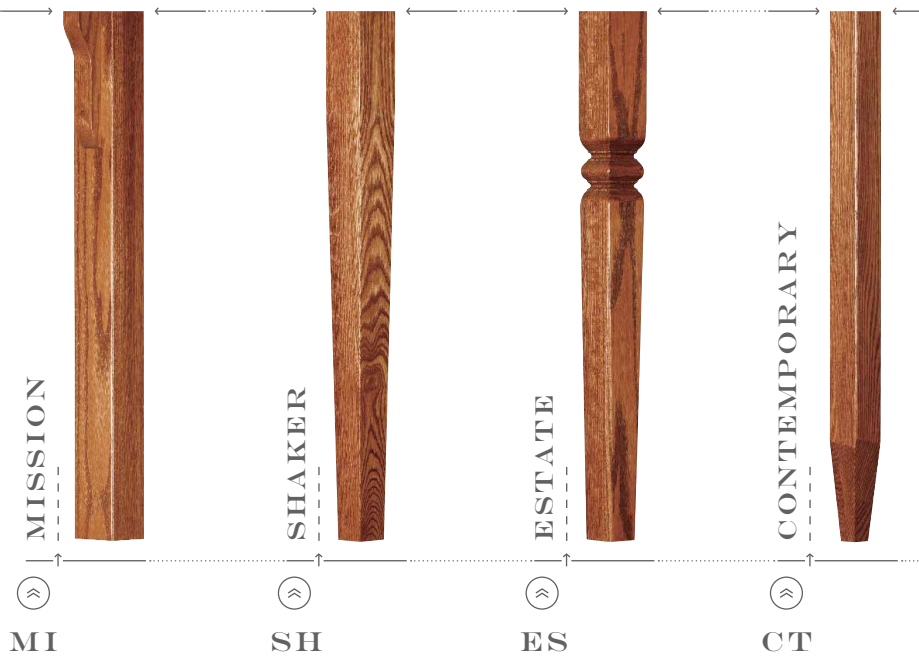

TABLE LEG *Options*



086

SHOWN: (116) Harvest on Red Oak

086: Extension Table with Optional Legs

SIZE: 42" D x 60" L x 30" H

SHOWN 151/152: Bow back chairs

FEATURES:

- » Extends to 42" D x 96" L with 3-12" boards
- » Self-storing leaves
- » Available in a 36" pub table height
- » Other leg styles available (see table leg options)

TABLE LEG OPTIONS

FEATURES:

- » Available in 30" table height or in a 36" pub table height
- » These table leg options are available on (043) Shaker Farm Table (049) Shaker 6' Farm Table (086) Ext. Table (636) Gathering Table (637) Round Gathering Table and (158) Transitional Dining Table





0820 | 082S

— SHOWN: (116) Harvest on Red Oak



158

— SHOWN: (116) Harvest on Red Oak



158: Transitional Dining Table

SIZE: 42" D x 60" L x 30" H

SHOWN 101: Venice side chairs

FEATURES:

- » Extends to 96" L with 3-12" leaves
- » Self-storing leaves
- » Available in a 36" pub table height
- » Other leg styles available

0820/082S: Mission Pedestal Table

SIZE: 42" D x 52" L x 30" H

SHOWN 151/152: Bow back chairs

FEATURES:

- » Available with oval or square top
- 0820:** Oval **082S:** Square
- » Extends to 76" L with 2-12" boards
- » Self-storing leaves



637

SHOWN: 2T (225) Mission Maple Top with (051) Black Base on Maple



636

SHOWN: (051) Black on Red Oak

636: Contemporary Gathering Table

SIZE: 36" D x 36" L x 36" H

SHOWN 624: Gathering chairs

FEATURES:

- » Available in a 30" table height
- » Other leg styles available

043ES: Estate Shaker 5' Farm Table

SIZE: 36" D x 60" L x 30" H

SHOWN 101: Venice side chairs

FEATURES:

- » **049ES:** Estate Shaker 6' farm table available
- » Available in a 36" pub table height
- » Other leg styles available

637: Round Gathering Table

SIZE: 42" D x 42" L x 36" H

SHOWN 623: 24" bar stools

FEATURES:

- » Available in a 30" table height
- » Other leg styles available



043ES | ——— SHOWN: (112) Provincial on Red Oak



049 | ——— SHOWN: (112) Provincial on Red Oak

SHOWN 049: 6' Shaker Farm Table

SIZE: 36" D x 72" L x 30" H

FEATURES:

- » 043: 5' Farm Table also available
- » 049/043: Available as a 36" pub table
- » Other leg styles available (see page 6)

043ES: Estate Shaker 5' Farm Table

SIZE: 36" D x 60" L x 30" H

SHOWN 101: Venice side chairs

FEATURES:

- » 049ES: Estate Shaker 6' farm table available
- » Available in a 36" pub table height
- » Other leg styles available



005

SHOWN: (116) Harvest on Red Oak

» Also available with a bonded leather seat. See the bonded leather page or ask for actual samples.



» Also available with a bonded leather seat. See the bonded leather page or ask for actual samples.

003

SHOWN: (112) Provincial on Red Oak



» Also available with a bonded leather seat. See the bonded leather page or ask for actual samples.

004

SHOWN: (112) Provincial on Red Oak



» AVAILABLE: 24" & 30" Heights



173: 3'
175: 5'

174

» Also available with a bonded leather seat. See the bonded leather page or ask for actual samples.



174: Mission 4' Bench

003: 3' Farm Bench

005: 5' Farm Bench

004: 4' Farm Bench

SIZE: 16" D x 48" L x 18" H

ALSO AVAILABLE:

- » 173: 3' Mission Bench
- » 175: 5' Mission Bench
- » 24" & 30" heights

FEATURES:

- » Available with solid wood or bonded leather seats
- » 10 bonded leather color choices available

SIZE: 12" D x 36" L x 18¹/₂" H

FEATURES:

- » Solid wood braces for sturdy and lasting strength
- » Available with solid wood or bonded leather seats
- » 10 bonded leather color choices available

SIZE: 12" D x 60" L x 18¹/₂" H

FEATURES:

- » Solid wood braces for sturdy and lasting strength
- » Available with solid wood or bonded leather seats
- » 10 bonded leather color choices available

SIZE: 12" D x 48" L x 18¹/₂" H

FEATURES:

- » Solid wood braces for sturdy and lasting strength
- » Available with solid wood or bonded leather seats
- » 10 bonded leather color choices available



109

SHOWN: (116) Harvest on Red Oak



110

SHOWN: (116) Harvest on Red Oak

110: Mission Sideboard

SIZE: 19" D x 52" L x 39 1/2" H

FEATURES:

- » Full extension glides
- » 2 doors with large storage area

109: Mission Huntboard

SIZE: 16" D x 52" L x 30" H

FEATURES:

- » Full extension glides



19" D
19" L
41³/₄" H



SHOWN: (116)
Harvest on Red Oak

131

19" D
23¹/₂" L
41³/₄" H



SHOWN: (116)
Harvest on Red Oak

132

BONDED LEATHER OPTIONS



All chairs and bar stools available with wood or bonded leather seats (except 151/152). Numerous bonded leather color choices. See the bonded leather page or ask for actual samples.



19" D
18" L
39¹/₄" H



SHOWN: 2T: (113) Michaels Cherry
Seats with (051) Black Frames

133

19" D
22¹/₄" L
39¹/₄" H



SHOWN: 2T: (113) Michaels Cherry
Seats with (051) Black Frames

134

19" D
19¹/₂" L
42³/₄" H



SHOWN: (116) Harvest
on Red Oak

051

19" D
26" L
42³/₄" H



SHOWN: (116) Harvest
on Red Oak

052

MISSION CHAIRS

- 133: Lincoln Side Chair
- 134: Lincoln Arm Chair
- 051: Mission Side Chair
- 052: Mission Arm Chair
- 131: Madison Side Chair
- 132: Madison Arm Chair

FEATURES:

- » Avail. with wood or bonded leather seats
- » Numerous bonded leather color choices available

» AVAILABLE: Wood seat only.

» AVAILABLE: Wood seat only.

» SHOWN: (SAN) Sand Leather



20" D
18" L
37" H

SHOWN: (116)
Harvest on Red Oak

151

20" D
21" L
37" H

SHOWN: (116)
Harvest on Red Oak

152

17³/₄" D
18¹/₄" L
38" H



SHOWN: (228)
Rich Tobacco Red Oak

101

16³/₄" D
18¹/₄" L
38" H



SHOWN: (118) Antique
Slate on Maple Wood

156

BONDED LEATHER OPTIONS



All chairs and bar stools available with wood or bonded leather seats (except 151/152). Numerous bonded leather color choices. See the bonded leather page or ask for actual samples.

» SHOWN: (BL) Black Leather

» SHOWN: (BUF) Buffalo Leather

» SHOWN: (TPE) Taupe Leather

» SHOWN: (CAM) Camel Leather



13¹/₂" D
17¹/₂" L
30" H



SHOWN: (116)
Harvest on Red Oak

625

13" D
17" L
24" H

SHOWN: (342)
Country White on Maple

623

14" D
14" L
30" H



SHOWN: (228) Rich
Tobacco on Maple

295

14" D
14" L
24" H



SHOWN:
Driftwood on Maple

293

BARSTOOLS

- 625: 30" Bar Stool
- 623: 24" Bar Stool
- 295: Mission 30" Barstool
- 293: Mission 24" Barstool

FEATURES:

- » Available with wood or bonded leather seats
- » Numerous bonded leather color choices available

CHAIRS

- 151: Bow Back Chair
- 152: Bow Back Arm Chair
- 101: Venice Side Chair

FEATURES:

- » Available with wood or bonded leather seats (except 151/152)
- » Numerous bonded leather color choices available



» FEATURE:
162/165 DIMMABLE, LED TOUCH LIGHTING



165

SHOWN: (116) Harvest on Red Oak



162

SHOWN: (116) Harvest on Red Oak

162: Deluxe Mission 2-Door China Hutch

SIZE: 20¹/₂" D x 42¹/₂" L x 78" H
INSIDE TOP: 13" D x 37¹/₂" L x 26¹/₂" H
INSIDE BASE: 18" D x 37¹/₄" L x 20" H

FEATURES:

- » LED dimmable touch lighting
- » 1 adjustable wood shelf in base
- » 1 adjustable glass shelf in top
- » Full extension glides, 100lb capacity



063

SHOWN: (116) Harvest on Red Oak

063: Mission 2-Door Buffet

SIZE: 20¹/₂" D x 41" L x 35" H
DOOR SPACE: 18" D x 37¹/₄" L x 20" H

FEATURES:

- » 1 adjustable shelf
- » Full extension glides with 100lb capacity



» FEATURE:

066/067 DIMMABLE, LED TOUCH LIGHTING



» FEATURE:

066/067 SOLID TONGUE & GROOVE BACKS



067

— SHOWN: (116) Harvest on Red Oak



066

— SHOWN: (116) Harvest on Red Oak

066: Transitional 2-Door China Hutch

SIZE: 20½" D x 42½" L x 81¼" H
INSIDE TOP: 13" D x 37½" L x 41" H
INSIDE BASE: 18" D x 37¼" L x 20" H

FEATURES:

- » LED dimmable touch lighting
- » adjustable wood shelf in base
- » 2 adjustable glass shelves in top
- » Full extension glides, 100lb capacity
- » Solid wood tongue & groove top back



065B

— SHOWN: (100) Natural on Red Oak

065B: Mission 3-Door China Base

SIZE: 20½" D x 59½" L x 35" H
INSIDE DOORS: 18" D x 54¼" L x 20" H

FEATURES:

- » 1 adjustable wood shelf in base
- » Full extension glides, 100lb capacity

Amish Made

PUB TABLES, ISLANDS

BARSTOOLS



IMPORTED FROM
ABSOLUTELY
NOWHERE

Do you ever wish for more space to socialize or desire more counter space to work on in your kitchen? Islands are the perfect answer. Along with being highly functional they are increasingly becoming the main social gathering place of the home. Whether yours is a large expansive kitchen or a unique kitchenette we have the solution. From large extension top Islands to smaller portable Butlers, you can create the perfect touch to the heart of your home.

» MADE IN LANCASTER, PA



ISLANDS, PUB TABLES | BARSTOOLS

★ NEW ★
Design

» **FEATURE**

» Convenient shelf accessible from the Sofa.



» **FEATURE**

» Shelf under top for convenient storage of phone chargers, glasses etc.



» **OPTIONAL**

» **P-22:** Power Hub - 2 USB / 2 AC outlets (Easily accessible from the Sofa or from the Bar side.)



ENHANCE YOUR LIVING SPACE!

Finally a great looking console that solves the issue of having a convenient place to serve drinks, eat dinner, do bookwork or homework *in your living space!* Whether it's serving drinks for a Super bowl party, or doing research on your laptop this is the perfect answer for adding a convenient multi-function work or serving area to your living space.

New



Perfect for behind a sofa, but also works great in a hallway or against any wall in the home!

SHOWN OPTIONAL

722 | 623

722: Crossway Sofa Bar

623: Manhattan Bar Stool 24

SIZE: 21" D x 72" L x 36" H

SIZE: 13" D x 17" L x 24" H

FEATURES:

- » Available with wood or bonded leather seats
- » Numerous bonded leather color choices available. See Options tab



637



636

636: Contemporary Gathering Table

SIZE: 36" D x 36" L x 36" H

SHOWN 624: Gathering chairs

FEATURES:

- » Available in a 30" table height
- » Other leg styles available

637: Round Gathering Table

SIZE: 42" D x 42" L x 36" H

SHOWN 623: 24" bar stools

FEATURES:

- » Available in a 30" table height
- » Other leg styles available

» FEATURE:
890/891 FINISHED & PANELED BACK



» FEATURE:
890/490 ISLAND TOP OPTIONS

- BB3060:** 30 x 60 » 1½" Butcher Block Island Top
- 2T3060:** 30 x 60 » 1½" Double Thick Edge Island Top
- R3060:** 30 x 60 » 1" Regular Island Top
- BB3652:** 36 x 52 » 1½" Butcher Block Island Top
- 2T3652:** 36 x 52 » 1½" Double Thick Edge Island Top
- R3652:** 36 x 52 » 1" Regular Island Top
- BB3660:** 36 x 60 » 1½" Butcher Block Island Top
- 2T3660:** 36 x 60 » 1½" Double Thick Edge Island Top
- R3660:** 36 x 60 » 1" Regular Island Top



SHOWN
890 | 891 » 891: Island with Extension Top

NUMEROUS TOP CHOICES:
SEE TOP OPTIONS LIST

» FEATURE:
490 PANELED
AND FINISHED BACK



490

490: Farmstead Island Base

SIZE: 25" D x 47" L x 34½" H

FEATURES:

- » Numerous top choices. See Top Options List
- » 1 adjustable wood shelf
- » Full extension glides with 100lb capacity

890: Monarch Island Base

SIZE: 24½" D x 43½" L x 34½" H

INSIDE DOORS: 21" D x 34½" L x 22¼" H

SHOWN BBT: 1½" thick butcher block top

FEATURES:

- » Numerous top choices. See TOP OPTIONS list.
- » 1 adjustable shelf
- » Full extension glides, 100lb capacity

891: Monarch Extension Island

SIZE: 36" D x 60" L x 36" H

INSIDE DOORS: 21" D x 34½" L x 22¼" H

FEATURES:

- » Extends to 84" with 2-12" leaves
- » Self storing leaves
- » 1 adjustable shelf
- » Solid wood gear driven slides
- » Full extension glides with 100lb capacity

BONDED LEATHER OPTIONS

» All chairs and bar stools available with wood or bonded leather seats. Numerous bonded leather color choices. See the bonded leather **under the options tab** or ask for actual samples.

» SHOWN: (BLK) Black Leather

» SHOWN: (BUF) Buffalo Leather

» SHOWN: (TPE) Taupe Leather

» SHOWN: (CAM) Camel Leather



13½" D
17½" L
30" H



13" D
17" L
24" H



14" D
14" L
30" H



14" D
14" L
24" H



625

623

295

293

» SHOWN: (TPE) Taupe Leather

» SHOWN: (FOG) Fog Leather



493

493: Farmstead 24" Bar Stools

SIZE: 14" D x 16" L x 24" H

FEATURES:

- » Wood seat has 1½" thick top edge
- » Available with wood or bonded leather seats
- » Numerous bonded leather color choices available



495

495: Farmstead 30" Bar Stools

SIZE: 17" D x 16" L x 30" H

FEATURES:

- » Wood seat has 1½" thick top edge
- » Available with wood or bonded leather seats
- » Numerous bonded leather color choices available



18" D
18¼" L
41" H

626

CHAIRS

626: 24" Bar Chair

624: 24" Bar Chair

FEATURES:

- » Available with wood or bonded leather seats
- » Numerous bonded leather color choices avail.



18" D
18¼" L
41" H

624

BARSTOOLS

295: Mission 30" Barstool

293: Mission 24" Barstool

625: 30" Barstool

623: 24" Barstool

FEATURES:

- » Available with wood or bonded leather seats
- » Numerous bonded leather color choices available

Amish Made
MONARCH

DINING

» COLLECTION



MONARCH

IMPORTED FROM
ABSOLUTELY
NOWHERE

The Monarch Collection is an attractive series with flared legs and arched rails that were inspired by a historic English bridge. Designed to be a classy yet economical line that has plenty of value in looks and function. This collection will grace your dining area with elegance and charm.

» MADE IN LANCASTER, PA

SHOWN: (2T) Two Tone Natural Tops, the rest in (226) Coffee on Maple Wood

MONARCH



AMISH MADE

MONARCH Dining

» COLLECTION

» 885 FEATURE:
| SELF STORING LEAVES



→ STANDARD HARDWARE ←

The Monarch Dining Collection comes standard with the **CM-S: Contemporary Pull**.

885

SHOWN: 2T Natural Top with (226) Coffee base on Maple Wood



» Also available with bonded leather seat » 10 color choices
See the bonded leather page or ask for actual samples.

881

SHOWN: 2T Natural Top with (226) Coffee base on Maple Wood



881: Monarch Side Chair

SIZE: 18" D x 19" L x 39" H

FEATURES:

- » Available with wood or bonded leather seats
- » 10 bonded leather color choices available



» Also available with bonded leather seat » 10 color choices
See the bonded leather page or ask for actual samples.

882

SHOWN: 2T Natural Top with (226) Coffee base on Maple Wood



882: Monarch Arm Chair

SIZE: 18" D x 25½" L x 39" H

FEATURES:

- » Available with wood or bonded leather seats
- » 10 bonded leather color choices available



» FEATURE:

886/887 SOLID WOOD TONGUE & GROOVE BACK



887

— SHOWN: 2T Natural Top with (226) Coffee base on Maple Wood



886B

— SHOWN: 2T Natural Top with (226) Coffee base on Maple Wood

886B: Monarch 2 Door Buffet

SIZE: 20 $\frac{1}{2}$ " D x 45" L x 36" H

INSIDE DOORS: 18 $\frac{1}{4}$ " D x 35 $\frac{1}{4}$ " L x 22 $\frac{1}{4}$ " H

FEATURES:

- » 1 adjustable shelves
- » Full extension glides, 100lb capacity
- » 1" thick top



886

— SHOWN: 2T Natural Top with (226) Coffee base on Maple Wood

886: Monarch 2 Door China

SIZE: 20 $\frac{1}{2}$ " D x 45" L x 84 $\frac{3}{4}$ " H

INSIDE TOP: 13" D x 37 $\frac{1}{4}$ " L x 33" H

INSIDE BASE: 18 $\frac{1}{4}$ " D x 35 $\frac{1}{4}$ " L x 22 $\frac{1}{4}$ " H

FEATURES:

- » 3-Phase LED concealed touch lights
- » Adjustable wood shelf in base
- » 2 adjustable glass shelves in top
- » Solid wood tongue and Groove back
- » Full extension glides, 100lb capacity
- » 1" thick top

» FEATURE:

ISLAND TOP OPTIONS

- BB3060:** 30x60 1½" Butcher Block Island Top
- 2T3060:** 30x60 1½" Double Thick Edge Island Top
- R3060:** 30x60 1" Regular Island Top
- BB3652:** 36x52 1½" Butcher Block Island Top
- 2T3652:** 30x52 1½" Double Thick Ddge Island Top
- R3652:** 36x52 1" Regular Island Top
- BB3660:** 36x60 1½" Butcher Block Island Top
- 2T3660:** 36x60 1½" Double Thick Edge Island Top
- R3660:** 36x60 1" Regular Island Top



887B

SHOWN: 2T Natural Top with (226) Coffee base on Maple Wood



» FEATURE:

890/891 FINISHED & PANELED BACK



SHOWN

890 891

SHOWN: 2T Natural Top with (226) Coffee base on Maple Wood

890: Monarch Island Base

SIZE: 24½" D x 43½" L x 34½" H
INSIDE DOORS: 21" D x 34½" L x 22¼" H
SHOWN BBT: 1½" thick butcher block top
FEATURES:
 » 1 adjustable shelf
 » Full extension glides, 100lb capacity
 » Numerous top choices:
 See TOP OPTIONS list

891: Monarch Extension Island

SIZE: 36" D x 60" L x 36" H
INSIDE DOORS: 21" D x 34½" L x 22¼" H
FEATURES:
 » Extends to 84" with 2-12" leaves
 » Self storing leaves
 » 1 adjustable shelf
 » Solid wood gear driven slides
 » Full extension glides with 100lb capacity

887B: Monarch 3 Door Buffet

SIZE: 20½" D x 62" L x 36" H
INSIDE DOORS: 18¼" D x 52" L x 22¼" H
FEATURES:
 » 1 adjustable shelf
 » Full extension glides, 100lb capacity
 » 1" thick top

» 880 FEATURE:

PULLOUT SERVING SHELF



880

— SHOWN: 2T Natural Top with (226) Coffee base on Maple Wood

» FEATURE:

880W WINE STORAGE & GOBLET RACKS



» FEATURE:

880W ADJUSTABLE CENTER SHELF



880W

— SHOWN: 2T Natural Top with (226) Coffee base on Maple Wood

880W: Monarch Wine Server

880: Monarch Server with Drawers

SIZE: 18" D x 52" L x 36" H

INSIDE DOORS: 14³/₄" D x 12³/₄" L x 21¹/₂" H

CENTER: 14³/₄" D x 15" L x 21¹/₂" H

FEATURES:

- » Room for at least 12 large bottles
- » Goblet racks - room for 16-20 goblets
- » Features 1 adjustable center shelf
- » 1 adjustable shelf each side
- » Full extension glides, 100lb capacity
- » 1" thick top

SIZE: 18" D x 52" L x 36" H

INSIDE DOORS: 14³/₄" D x 12³/₄" L x 21¹/₂" H

CENTER OPENING: 14³/₄" D x 15" L x 6¹/₂" H

FEATURES:

- » Pullout serving shelf
- » 1 adjustable shelf each side
- » Full extension glides, 100lb capacity
- » 1" thick top

Amish Made
OCCASIONAL COLLECTION

» COUNTRY CLASSIC COLLECTION



CELEBRATING ^{***} *30* Years

★ IMPORTED ★
FROM
ABSOLUTELY
Nowhere

Your living space is the heartbeat of the home. It is the gathering place of family and the place to entertain and socialize with guests. Welcome your guests with hospitality and create a harmonious space for your family to connect and bond. Choose from our wide selection of beautiful and functional living pieces to create the ultimate expression of who you are. Your guests will know you value quality American Craftsmanship and your family will appreciate the durability of furnishings that are built for living, built for life.

» MADE IN LANCASTER, PA

OCCASIONAL



AMISH MADE

OCCASIONAL *Preview*



AMERICAN CLASSIC | 506



CRAFTSMEN | 244

-New-



CROSSWAY | 730



MANHATTAN | 654



MISSION | 060



MONARCH | 826



FARMSTEAD | 440



RENO | 940G



SIMPLICITY | 437



Amish Made
AMERICAN

CLASSIC

» COLLECTION



IMPORTED FROM
ABSOLUTELY
NOWHERE

The American Classic Collection presents furniture in the Shaker tradition, known for its beauty and functionality. The Shakers rejected the notion of decorating a table with curved feet or inlay, preferring to build tables with sturdy legs and tops. Our craftsmen have the same commitment to honest and pure design that inspired the Shakers to build such furniture.

» MADE IN LANCASTER, PA



AMISH MADE

AMERICAN CLASSIC *Occasional*

» COLLECTION



502

SHOWN: (116) Harvest on Red Oak



071

SHOWN: (116) Harvest on Red Oak



STANDARD HARDWARE

The American Classic Collection comes standard with the attractive solid **WK: Wooden Knob**.

071: Shaker 2-Door Console

SIZE: 13" D x 32" L x 30" H

FEATURES:

» One adjustable shelf

502: Shaker 1-Door End Table

SIZE: 20" D x 20 1/2" L x 23" H

FEATURES:

» Full extension glides



506

SHOWN: (116) Harvest on Red Oak



504

SHOWN: (116) Harvest on Red Oak

503

SHOWN: (116) Harvest on Red Oak

504: Shaker Hall Console

SIZE: 14" D x 39 1/2" L x 28 1/2" H

FEATURES:

- » One adjustable shelf
- » Full extension glides

506: Shaker 1-Door Chair-Side Table

SIZE: 20 1/4" D x 16 1/2" L x 26 1/2" H

FEATURES:

- » Full extension glides

503: Shaker 2-Door Coffee Table

SIZE: 22" D x 44" L x 18" H



074 ——— SHOWN: (116) Harvest on Red Oak

074: Shaker 2-Door Jelly Cabinet

SIZE: 13" D x 38" L x 49" H

FEATURES:

- » Two adjustable shelves



073 ——— SHOWN: (116) Harvest on Red Oak

073: Shaker 1-Door Jelly Cabinet

SIZE: 13" D x 22" L x 49" H

FEATURES:

- » Two adjustable shelves



070 ——— SHOWN: (116) Harvest on Red Oak

070: Shaker 1-Door Nightstand

SIZE: 13" D x 17½" L x 27" H

FEATURES:

- » One adjustable shelf





OPTIONAL
001 | 009 | ——— SHOWN: (112) Provincial on Red Oak



059 | ——— SHOWN: (112) Provincial on Red Oak

059: Shaker 4-Drawer Candle Stand

SIZE: 10" D x 15 1/2" L x 30" H

FEATURES:

- » Wood on wood drawer slides



084 | ——— SHOWN: (112) Provincial on Red Oak

084: Shaker Catch-all Cabinet

SIZE: 10" D x 30" L x 30" H

FEATURES:

- » Wood on wood drawer slides

001: Shaker Phone Stand

SIZE: 12 5/8" D x 15 7/8" L x 23" H

OPTIONAL 009: Drawer

FEATURES:

- » Wood-on-wood drawer slides



003

SHOWN: (112) Provincial on Red Oak



Also available with bonded leather seat.
See the bonded leather page or ask for actual samples.



004

SHOWN: (112) Provincial on Red Oak



Also available with bonded leather seat.
See the bonded leather options page or ask for actual samples.



005

SHOWN: (116) Harvest on Red Oak



Also available with bonded leather seat.
See the bonded leather options page or ask for actual samples.



005: 5' Farm Bench

SIZE: 12" D x 60" L x 18½" H

FEATURES:

- » Solid wood braces for sturdy and lasting strength
- » Available with solid wood or bonded leather seats

003: 3' Farm Bench

SIZE: 12" D x 36" L x 18½" H

FEATURES:

- » Solid wood braces for sturdy and lasting strength
- » Available with solid wood or bonded leather seats

004: 4' Farm Bench

SIZE: 12" D x 48" L x 18½" H

FEATURES:

- » Solid wood braces for sturdy and lasting strength
- » Available with solid wood or bonded leather seats

Amish Made
CRAFTSMEN

OCCASIONAL

CRAFTSMEN

» **COLLECTION**



IMPORTED FROM
ABSOLUTELY
NOWHERE

The Craftsmen Collection is a series of strongly crafted pieces, designed with a contemporary flare, yet it retains the integrity of old-world craftsmanship. These attractive designs with stylish, wrought-iron pulls will be a beautiful complement to your home.

» MADE IN LANCASTER, PA

CRAFTSMEN



AMISH MADE

CRAFTSMEN *Occasional*

» COLLECTION



249 | ——— SHOWN: (116) Harvest on Rustic Cherry Wood



NEW
Design

234 | ——— SHOWN: LD: Light Distressing (110) Medium on Rustic Cherry



247 | ——— SHOWN: (116) Harvest on Rustic Cherry Wood



→ STANDARD HARDWARE ←

The Craftsmen Collection comes standard with the **CR-B: Craftsmen Pull** a stylish wrought-iron pull.

247: Craftsmen Sofa Table

SIZE: 16" D x 46" L x 30" H

FEATURES:

- » Full extension glides

249: Craftsmen 56" Entertainment

SIZE: 19" D x 56" L x 30" H

SIDE SHELF: 6½" D x 14" L x 10" H

CENTER SLOT: 14" D x 37" L x 21" H

FEATURES:

- » Full extension glides
- » 2 adjustable shelves

234: Craftsmen Wedge Table

SIZE: 24" D x 16-9" L x 23" H



245

SHOWN: (116) Harvest on Rustic Cherry Wood



235

SHOWN: (116) Harvest on Rustic Cherry Wood



240

SHOWN: (116) Harvest on Rustic Cherry Wood



244

SHOWN: (116) Harvest on Rustic Cherry Wood

240: Craftsmen Large End Table

245: Craftsmen Large Coffee Table

235: Craftsmen Phone Stand

244: Craftsmen Chairside Table

SIZE: 26" D x 26" L x 23" H

SIZE: 25" D x 50" L x 18" H

SIZE: 16" D x 19" L x 30" H

SIZE: 26" D x 14" L x 23" H

FEATURES:

FEATURES:

FEATURES:

FEATURES:

» Full extension glides

» Full extension glides

» Full extension glides

» Full extension glides



242

SHOWN: 2T (226) Coffee Top with (348) Chelsea Grey Base on Maple



243

SHOWN: 2T (226) Coffee Top with (348) Chelsea Grey Base on Maple



243: Craftsmen Console Table

SIZE: 16" D x 36" L x 30" H
FEATURES:
 » Full extension glides



241

SHOWN: 2T (226) Coffee Top with (348) Chelsea Grey Base on Maple



241: Craftsmen End Table

SIZE: 22" D x 19" L x 23" H
FEATURES:
 » Full extension glides



» FEATURE:

| ROLL-OUT STORAGE CHEST



252

— SHOWN: 2T (227) Rich Cherry Top with (118) Antique Slate on Maple

252: Craftsmen Hall Seat with Storage

SIZE: 17" D x 45¹/₄" L x 71" H

FEATURES:

- » Beveled mirror
- » Roll-out storage chest



142

SHOWN: (108) S-14 on Rustic Cherry Wood



141

SHOWN: (108) S-14 on Rustic Cherry Wood



144

SHOWN: (108) S-14 on Rustic Cherry Wood



141: Craftsmen End Table

SIZE: 18" D x 22" L x 23" H

FEATURES:

- » Large storage area for books and other misc. items

142: Craftsmen Coffee Table

SIZE: 18" D x 42" L x 18" H

144: Craftsmen Chairside

SIZE: 20½" D x 18" L x 28" H

FEATURES:

- » Full extension glides



147

— SHOWN: (108) S-14 on Rustic Cherry Wood



148

— SHOWN: Natural on Rustic Cherry



148: Craftsmen 4-Door Ent. Credenza

SIZE: 18" D x 65" L x 36" H
INSIDE CENTER: 15" D x 29" L x 20" H
INSIDE SIDE: 15" D x 12" L x 20" H
CENTER SLOT: 15" D x 28" L x 6 1/2" H
DRAWERS: 13" D x 10" L x 5 3/4" H
FEATURES:
 » 2 adjustable shelves each side
 » 2 adjustable center shelves

147: Craftsmen Entertainment Center

SIZE: 18" D x 46" L x 30" H
INSIDE SIZE: 15" D x 40" L x 22" H
FEATURES:
 » 2 adjustable shelves



146

— SHOWN: (108) S-14 on Rustic Cherry Wood



143

— SHOWN: (108) S-14 on Rustic Cherry Wood



143: Craftsmen Console

SIZE: 13½" D x 37" L x 30" H
INSIDE SIZE: 10½" D x 31" L x 23" H
FEATURES:
 » 2 adjustable shelves

146: Craftsmen Bookcase

SIZE: 15" D x 40" L x 61" H
INSIDE SIZE: 12" D x 34" L x 54" H
FEATURES:
 » 4 adjustable shelves

Amish Made

CROSSWAY

OCCASIONAL

» COLLECTION



CROSSWAY

**IMPORTED FROM
ABSOLUTELY
NOWHERE**

Crossway speaks of new roads.... take the journey, embrace the tastefully modern appeal of this collection. Soft, eased edges and rounded corners make this transition a delight. The appeal is completed with metal rods that beautifully fulfill the crossing from transitional to modern taste while remaining open and inviting.

» **MADE IN LANCASTER, PA**

SHOWN: (121) Smoke on Maple Wood

CROSSWAY



AMISH MADE

CROSSWAY *Occasional*

» COLLECTION



730

SHOWN: (121) Smoke on Maple Wood



LARGER PULLS



STANDARD HARDWARE

The Crossway Collection comes standard with the **BF-B: Belfast Pull** (5" C-C)



729

SHOWN: (121) Smoke on Maple Wood



NEW
Design

734

SHOWN: AT: Antiquing (121) Smoke on Maple

729: Crossway Large Ent. Table

SIZE: 18" D x 56" L x 29" H
SIDE SHELF: 9" D x 13³/₄" L x 9¹/₂" H
CENTER SLOT: 15¹/₂" D x 33¹/₄" L x 20¹/₂" H

FEATURES:

- » Full extension glides
- » 2 adjustable shelves

730: Crossway Chairside Table

SIZE: 22¹/₂" D x 15" L x 23" H

FEATURES:

- » Full extension glides

734: Crossway Wedge Table

SIZE: 24" D x 18-11" L x 23" H



724

— SHOWN: (121) Smoke on Maple Wood



735

— SHOWN: (121) Smoke on Maple Wood



720

— SHOWN: (121) Smoke on Maple Wood



725

— SHOWN: (121) Smoke on Maple Wood

720: Crossway Large End Table

724: Crossway Console Table

735: Crossway Phone Stand

725: Crossway Lg Coffee Table

SIZE: 26" D x 20" L x 23" H

SIZE: 14" D x 36" L x 29" H

SIZE: 14" D x 16" L x 29" H

SIZE: 24 1/4" D x 50" L x 18" H

FEATURES:

FEATURES:

FEATURES:

FEATURES:

» Full extension glides

» Full extension glides

» Full extension glides

» Full extension glides



727

SHOWN: (121) Smoke on Maple Wood



728

SHOWN: (121) Smoke on Maple Wood



726

SHOWN: (121) Smoke on Maple Wood

728: Crossway 3' Bookcase

SIZE: 12" D x 36" L x 47" H
FIXED SHELVES: 10" D x 31" L x 12 1/4" H

727: Crossway 2 Drawer Sofa Table

SIZE: 14" D x 46" L x 29" H
FEATURES:
 » Full extension glides

726: Crossway 2' Bookcase

SIZE: 12" D x 24" L x 47" H
FIXED SHELVES: 10" D x 19" L x 12 1/4" H

STANDARD FEATURES

STANDARD FEATURES

- » File drawer/holds letter or legal paper
- » Classy side panels
- » Dual usb charging port in keyboard drawer

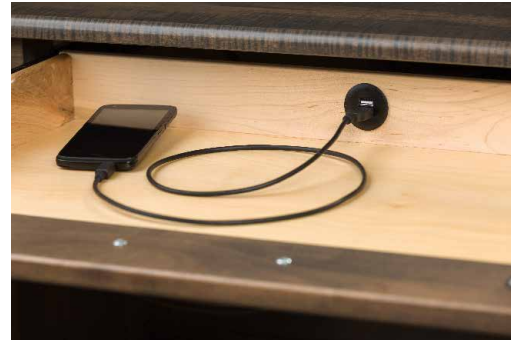

732 — SHOWN: (121) Smoke on Maple Wood

OPTIONAL FEATURES

OPTIONAL FEATURES:

- » **H-L3:** power hub » 1 ac outlet » 2 usb charging ports
- » **P-6:** power strip » 6 ac outlets (gets mounted in back of kneehole)



P-6

H-L3

732: Crossway Students Desk

OPTIONAL H-L3: Large Hub/USB Ports

OPTIONAL P-6: Power Strip

SIZE: 20" D x 50" L x 30" H
KNEEHOLE SIZE: 18" D x 30" L x 25³/₄" H
FEATURES:

FEATURES:
 » Large Hub with 1 AC outlet and 2 USB ports

FEATURES:
 » Power strip with 6 AC outlets

- » Keyboard drawer
- » Dual USB charging port in KB drawer
- » File drawer holds legal or letter files
- » Wiring hole in top with wooden grommet

Amish Made

MANHATTAN

OCCASIONAL

» COLLECTION



MANHATTAN

**IMPORTED FROM
ABSOLUTELY
NOWHERE**

The Manhattan Collection is contemporary stylish with exceptionally clean lines. These beautifully crafted pieces are made with solid wood oak dovetail drawers, stylish brushed nickel pulls, and full-extension ball-bearing glides. Sharply splayed legs give it a sophisticated, yet well balanced, look. Modern Design – Old World Craftsmanship

» **MADE IN LANCASTER, PA**



MANHATTAN

AMISH MADE

MANHATTAN *Occasional*

» COLLECTION



STANDARD HARDWARE

The Manhattan Collection comes standard with the **BP-S: Contemporary Bar Pull**.



651 — SHOWN: (227) Rich Cherry on Maple



654 — SHOWN: (227) Rich Cherry on Maple



652 — SHOWN: (227) Rich Cherry on Maple

652: Contemporary Coffee Table

SIZE: 20" D x 48" L x 18" H

FEATURES:

» Full extension glides

651: Contemporary End Table

SIZE: 26" D x 20" L x 23" H

FEATURES:

» Full extension glides

654: Contemporary Chair Side Table

SIZE: 24" D x 14" L x 23" H

FEATURES:

» Full extension glides



655

SHOWN: (227) Rich Cherry on Maple



653

SHOWN: (227) Rich Cherry on Maple



657

SHOWN: (051) Black on Maple



657: Contemporary Credenza/Ent.

SIZE: 16½" D x 56" L x 30" H
DOOR SPACE: 14" D x 24" L x 16" H

FEATURES:

- » Full extension glides
- » Glass doors for easy remote access
- » One adjustable shelf

655: Contemporary Phone Stand

SIZE: 15" D x 18" L x 29" H

FEATURES:

- » Full extension glides

653: Contemporary Console

SIZE: 15" D x 34" L x 29" H

FEATURES:

- » Full extension glides

Amish Made
MISSION

OCCASIONAL

» **COLLECTION**



MISSION

IMPORTED FROM
ABSOLUTELY
NOWHERE

The Mission Collection reflects a style of furniture known as Mission, Arts & Crafts, Craftsman, and Quaint, introduced to America by the designer Gustav Stickley. This traditional Mission line crowns your living space with integrity and clearly states that you value strength and timeless beauty.

» MADE IN LANCASTER, PA



AMISH MADE

MISSION *Occasional*

» COLLECTION



STANDARD HARDWARE

The Mission Occasional Collection comes standard with the **M-B: Classic Mission-Style Hardware**.



030 — SHOWN: (116) Harvest on Red Oak



NEW Design

034 — SHOWN: 2T: Two Tone (104) Seely top and (342) Country White base with RP: Rubthrough on Maple



026 — SHOWN: (116) Harvest on Red Oak

026: Mission End Table

SIZE: 18" D x 22" L x 23" H



031 — SHOWN: (116) Harvest on Red Oak

031: Mission Chair-Side Table w/ Drawer

SIZE: 24" D x 18-11" L x 23" H



034: Mission Wedge Table

SIZE: 26" D x 14" L x 23" H

FEATURES:

» Full extension glides



060

SHOWN: (116) Harvest on Red Oak



044

SHOWN: (116) Harvest on Red Oak



045

SHOWN: (116) Harvest on Red Oak



097

SHOWN: (116) Harvest on Red Oak

045: Mission Large Coffee Table

060: Mission End Table

044: Mission Console Table

097: Mission 2-Door Sofa Table

SIZE: 25" D x 50" L x 18" H

SIZE: 26" D x 20" L x 23" H

SIZE: 15" D x 36" L x 29" H

SIZE: 15" D x 46" L x 29" H

FEATURES:

FEATURES:

FEATURES:

FEATURES:

» Full extension glides

» Full extension glides

» Full extension glides

» Full extension glides

» FEATURE:

061 STORAGE DETAIL

» NOTE: (061) Comes standard with a wooden seat. Please clearly specify if you want a leather seat.



061

SHOWN: (116) Harvest on Red Oak

» OPTIONAL: Choose from 10 bonded leather color choices. See the bonded leather page or ask for actual samples.



033

SHOWN: (116) Harvest on Red Oak

033: Mission Magazine Table

SIZE: 15" D x 21" L x 25" H

FEATURES:

- » Rack for magazine storage or other misc. items



041

SHOWN: (116) Harvest on Red Oak

041: Mission 3-Drawer Sofa Table

SIZE: 15" D x 60" L x 29" H

FEATURES:

- » Full extension glides





112

— SHOWN: (116) Harvest on Red Oak



083

— SHOWN: (116) Harvest on Red Oak

083: Mission Clothes Tree

SIZE: 18" D x 18" L x 67³/₄" H

112: Mission Wall Hanger

SIZE: 4¹/₂" D x 46" L x 17¹/₂" H

FEATURES:

- » Convenient hooks
- » Can also be ordered without hooks



088

— SHOWN: (116) Harvest on Red Oak

080

— SHOWN: (116) Harvest on Red Oak



088: Mission Wall Mirror

SIZE: 4¹/₂" D x 32³/₄" L x 36¹/₄" H

FEATURES:

- » Convenient hooks
- » Can also be ordered without hooks

080: Mission Quilt Rack

SIZE: 10¹/₄" D x 38" L x 33" H



037

SHOWN: (116) Harvest on Red Oak



035

SHOWN: (116) Harvest on Red Oak



078

SHOWN: (228) Rich Tobacco on Red Oak



079

SHOWN: (116) Harvest on Red Oak

078: Mission Laptop Server

SIZE: 18" D x 14" L x 27³/₄" H
FEATURES:

» Designed to slide over the arm or front of sofas and chairs or to be used as a chairside table.

037: Mission Plant Stand

SIZE: 12¹/₂" D x 12¹/₂" L x 30" H

035: Mission Phone Stand

SIZE: 14" D x 16" L x 30" H
SPECIES SHOWN: Oak
FINISH: Available in all finishes
FEATURES:

» Full extension glides

079: Mission Sofa Server

SIZE: 14" D x 12" L x 27³/₄" H
FEATURES:

» Designed to slide over the arm or front of sofas and chairs or to be used as a chairside table.



046

SHOWN: (116) Harvest on Red Oak



048

SHOWN: (116) Harvest on Red Oak



046B

SHOWN: (116) Harvest on Red Oak



048B

SHOWN: (116) Harvest on Red Oak

046B: Mission 2' Bookshelf with Back

046: Mission 2' Bookshelf

048: Mission 3' Bookshelf

048B: Mission 3' Bookshelf with Back

SIZE: 11" D x 24" L x 50½" H
SHELF SIZE: 9½" D x 20½" L x 12" H

SIZE: 12" D x 24" L x 47" H
SHELF SIZE: 9½" D x 20½" L x 12" H

SIZE: 12" D x 36" L x 47" H
SHELF SIZE: 9½" D x 32½" L x 12" H

SIZE: 11" D x 36" L x 50½" H
SHELF SIZE: 9½" D x 32½" L x 12" H



046T

SHOWN: (119) Cappuccino on Maple



048T

SHOWN: (119) Cappuccino on Maple



046BT

SHOWN: (119) Cappuccino on Maple



048BT

SHOWN: (119) Cappuccino on Maple

046BT: Mission 6' Bookshelf with Back

046T: Mission 6' Bookshelf

048T: Mission 6' Bookshelf

048BT: Mission 6' Bookshelf with Back

SIZE: 11" D x 24" L x 75½" H
SHELF SIZE: 9½" D x 20½" L x 12" H

SIZE: 12" D x 24" L x 72" H
SHELF SIZE: 9½" D x 20½" L x 12" H

SIZE: 12" D x 36" L x 72" H
SHELF SIZE: 9½" D x 32½" L x 12" H

SIZE: 11" D x 36" L x 75½" H
SHELF SIZE: 9½" D x 32½" L x 12" H



081

— SHOWN: (116) Harvest on Red Oak



095

— SHOWN: (116) Harvest on Red Oak

095: Mission Bookcase

SIZE: 14½" D x 34" L x 50¼" H
INSIDE SPACE: 12" D x 27½" L x 45" H
FEATURES:
 » 3 adjustable shelves



096

— SHOWN: (116) Harvest on Red Oak

096: Mission Bookcase with Drawer

SIZE: 14½" D x 34" L x 60¼" H
INSIDE SPACE: 12" D x 27½" L x 45" H
FEATURES:
 » 3 adjustable shelves
 » Full extension glides



135

» **OPTIONAL:** Choose from 10 bonded leather color choices. See the bonded leather page or ask for actual samples.
 ----- SHOWN: (116) Harvest on Red Oak



» FEATURE:

032 | 050 KEYBOARD DRAWER



032

----- SHOWN: (116) Harvest on Red Oak



050

----- SHOWN: (116) Harvest on Red Oak



032: Mission Library Desk

SIZE: 25" D x 50" L x 30" H

FEATURES:

- » Keyboard drawer
- » Full extension glides
- » **OPTIONAL H-S2:** Dual USB charging port in drawer - See Office section for photos
- » **OPTIONAL HL-3:** Large Hub with 1 AC outlet and 2 USB ports

135: Mission Office Chair w/ Gas Lift

SIZE: 25" D x 25" L x 46" H

FEATURES:

- » Gas lift
- » Available with wood or bonded leather seat
- » 10 bonded leather color choices available

050: Mission Computer Table

SIZE: 20" D x 32" L x 30" H

FEATURES:

- » Keyboard drawer
- » Full extension glides
- » **OPTIONAL H-S2:** Dual USB charging port in drawer - See Office section for photos

» FEATURE:

118 STORAGE DETAIL



118

SHOWN: (116) Harvest on Red Oak



108

SHOWN: (116) Harvest on Red Oak

108: Mission Secretary Laptop Desk

SIZE: 15" D x 24 1/4" L x 41" H
TOP SHELF: 7" D x 20 1/4" L x 6" H
LID SPACE: 12 1/2" tapers 9 1/4" D x 20 1/4" W
DOOR SPACE: 12 1/2" D x 20 1/4" L x 7" H

FEATURES:

- » Full extension glides
- » Small supply shelf behind lid

118: Mission Large Secretary Desk

SIZE: 19 1/4" D x 36 1/4" L x 41" H
TOP SHELF: 11" D x 32 1/4" L x 6" H
LID SPACE: 16 1/2" tapers 13" D x 32 1/4" W
DOOR SPACE: 16 1/2" D x 15 1/2" L x 16" H

FEATURES:

- » Full extension glides
- » File drawer holds legal or letter size files
- » Supply shelf above file drawer
- » 1 adjustable shelf



089

SHOWN: (116) Harvest on Red Oak



027

SHOWN: (116) Harvest on Red Oak



064

SHOWN: (116) Harvest on Red Oak



098

SHOWN: (116) Harvest on Red Oak



064: Mission TV Table

SIZE: 20" D x 30" L x 29" H
TOP SHELF: 16½" D x 23" L x 5" H
BOTTOM SHELF: 16½" D x 23" L x 10" H
FEATURES:
 » Full extension glides

089: Mission Large Ent. Table

SIZE: 18" D x 56" L x 30" H
CENTER SPACE: 13" D x 32" L x 20" H
SIDE SHELVES: 6½" D x 12" L x 10½" H
FEATURES:
 » 2 adjustable center shelves
 » 4 side shelves

027: Mission Coffee Table

SIZE: 18" D x 42" L x 18" H

098: Mission Entertainment Table

SIZE: 18" D x 42" L x 23" H
CENTER SPACE: 13¾" D x 18" L x 17" H
SIDE SHELVES: 6½" D x 12" L x 8" H
FEATURES:
 » 1 adjustable center shelf
 » 4 side shelves



100B

SHOWN: (116) Harvest on Red Oak



117G

SHOWN: (116) Harvest on Red Oak

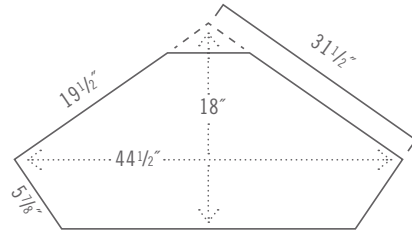

» SPEC:

119 | **119G** FOOTPRINT



119G

SHOWN: (116) Harvest on Red Oak



119

SHOWN: (116) Harvest on Red Oak



119G: Mission Corner Ent. Cabinet

100B: Mission TV Ent. Center

117G: Mission 3 Door Media Cabinet

119: Mission Corner Ent. Cabinet

SIZE: 18" D x 44¹/₄" L x 30" H

SLOT SPACE: 18" D x 32" L x 5³/₄" H

INSIDE DOORS: 18" D x 32" L x 15³/₄" H

FEATURES:

- » Adjustable shelf
- » Glass doors

SIZE: 20" D x 62" L x 32" H

GLASS DOORS: 17³/₄" D x 29" L x 25" H

WOOD DOORS: 17³/₄" D x 12" L x 25" H

FEATURES:

- » 2 adjustable center shelves
- » 2 adjustable shelves each side
- » comes with wheels

SIZE: 20" D x 53" L x 30" H

CENTER DOOR: 18" D x 17¹/₂" L x 22" H

SIDE DOORS: 18" D x 12¹/₂" L x 22" H

FEATURES:

- » 2 adjustable center shelves
- » 2 adjustable shelves each side
- » Center glass door

SIZE: 18" D x 44¹/₄" L x 30" H

SLOT SPACE: 18" D x 32" L x 5³/₄" H

INSIDE SPACE: 18" D x 32" L x 15³/₄" H

FEATURES:

- » Adjustable shelf



117

SHOWN: (116) Harvest on Red Oak



105

SHOWN: (116) Harvest on Red Oak

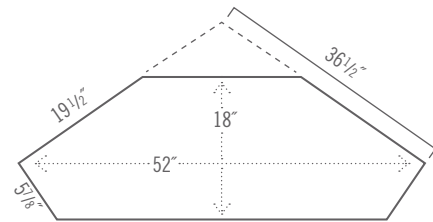

» SPEC:

120 | 120G FOOTPRINT



120

SHOWN: (116) Harvest on Character Cherry



120G

SHOWN: 2T Natural Top with (121) Smoke Base on Character Cherry



120: Mission LG Corner Entertainment

117: Mission 2-Door Media Cabinet

105: Mission TV Entertainment Cabinet

120G: Mission LG Corner Entertainment

SIZE: 18" D x 52" L x 30" H

INSIDE DOORS: 15" D x 39 1/2" L x 16 1/4" H

COMPONENT SLOT: 15" D x 39 1/2" L x 5 1/2" H

FEATURES:

» Adjustable shelf

SIZE: 20" D x 53" L x 30" H

CENTER: 18" D x 17 1/2" L x 22" H

SIDE DOORS: 18" D x 12 1/2" L x 22" H

FEATURES:

» 2 adjustable center shelves

» 2 adjustable shelves each side

SIZE: 20" D x 44" L x 30" H

SLOT SPACE: 17 3/4" D x 35 1/2" L x 5 1/2" H

INSIDE SPACE: 17 3/4" D x 35 1/2" L x 16" H

FEATURES:

» Adjustable shelf

SIZE: 18" D x 52" L x 30" H

INSIDE DOORS: 15" D x 39 1/2" L x 16 1/4" H

COMPONENT SLOT: 15" D x 39 1/2" L x 5 1/2" H

FEATURES:

» Adjustable shelf

» Glass doors



102

SHOWN: (116) Harvest on Red Oak



103

SHOWN: (116) Harvest on Red Oak

103: Mission 2-Door Coffee Table

102: Mission 1-Door End Table

SIZE: 22" D x 44" L x 18" H

SIZE: 20" D x 20 1/2" L x 23" H

FEATURES:

» Full extension glides



104

SHOWN: (116) Harvest on Red Oak



106

SHOWN: (116) Harvest on Red Oak

106: Mission 1-Door Chair-Side Table

104: Mission Hall Console with Doors

SIZE: 20" D x 16 1/2" L x 26 1/4" H

FEATURES:

- » Full extension glides

SIZE: 14 1/2" D x 39 1/2" L x 28 1/2" H

FEATURES:

- » 1 adjustable shelf
- » Full extension glides

★ NEW ★
Design

SHARE YOUR MEMORIES

SHARE *your passion*

» 045G FEATURE:

CONCEALED PULL-OUT DISPLAY



» 045G FEATURE:

BEVELED GLASS

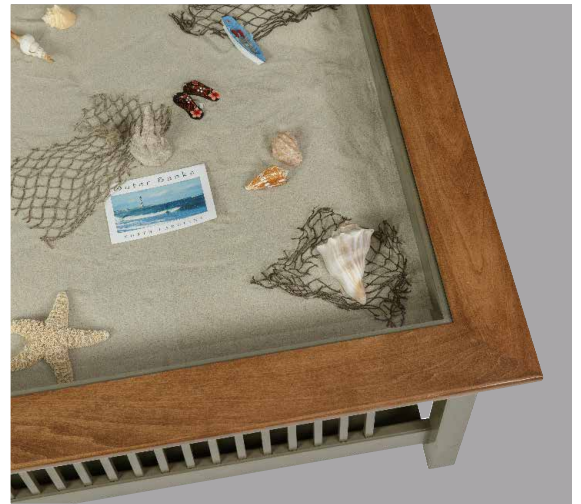

» 045G FEATURE:

SHOWN EMPTY



045G

— SHOWN: (226) Coffee on Maple Wood

045G: Mission Large Glass Coffee Table

SIZE: 30" D x 50" L x 18" H

DISPLAY CASE INSIDE:

21" D x 50" L x 3 1/2" H

FEATURES:

- » Beveled glass top
- » Concealed pull-out display for easier access

Amish Made
MONARCH

OCCASIONAL

» COLLECTION



IMPORTED FROM
ABSOLUTELY
NOWHERE

The Monarch Collection is an attractive series with flared legs and arched rails that were inspired by a historic English bridge. Designed to be a classy yet economical line that has plenty of value in looks and function. These pieces will add elegance and charm to any room in your home.

» MADE IN LANCASTER, PA



AMISH MADE

MONARCH

Occasional

» COLLECTION



826

SHOWN: (227) Rich Cherry on Maple Wood



NEW
Design

834

SHOWN: 2T: Two Tone (100) Natural top and (228) Rich Tobacco on Wormy Maple



897

SHOWN: (227) Rich Cherry on Maple Wood

897: Monarch Sofa Table

SIZE: 16" D x 42" L x 29" H



830

SHOWN: (227) Rich Cherry on Maple Wood

826: Monarch Wedge Table

SIZE: 24" D x 16-9" L x 23" H

830: Monarch Chairside Table

SIZE: 26" D x 15" L x 23" H



898

SHOWN: (227) Rich Cherry on Maple Wood



846

SHOWN: (227) Rich Cherry on Maple Wood

846: Monarch 2' Bookcase

SIZE: 15" D x 24" L x 47" H
SHELF SIZE: 11" D x 17" L x 12" H



848

SHOWN: (227) Rich Cherry on Maple Wood

848: Monarch 3' Bookcase

SIZE: 15" D x 36" L x 47" H
SHELF SIZE: 11" D x 29" L x 12" H

898: Monarch Entertainment Table

SIZE: 18" D x 42" L x 29" H
CENTER SPACE: 13" D x 20 1/4" L x 19" H
SIDE SHELVES: 7" D x 13" L x 9" H
FEATURES:
» 2 adjustable shelves



805

SHOWN: (112) Provincial on Maple wood



813

(228) Rich Tobacco on Maple wood with Taupe bonded leather



827

SHOWN: (227) Rich Cherry on Maple Wood



835

SHOWN: (227) Rich Cherry on Maple Wood

827: Monarch Coffee Table

SIZE: 18" D x 42" L x 18" H

805: Monarch Open Tiered Nightstand

SIZE: 15" D x 22" L x 27" H

813: Monarch Bench

SIZE: 16" D x 40" L x 18" H

FEATURES:

- » Available with a solid wood or bonded leather seat
- » Numerous bonded leather choices available
- » Great bedside or window seat

835: Monarch Phone Stand

SIZE: 15" D x 20" L x 29" H

Amish Made

FARMSTEAD

OCCASIONAL

» COLLECTION



IMPORTED FROM
ABSOLUTELY
NOWHERE

This collection was designed in commemoration of our 25th anniversary of American Craftsmanship. It is constructed with the heavy Timber Frame construction of the Olde Farmstead where the Country Classic Collection began a quarter century ago. It is crafted with the same meticulous integrity with which our forefathers built our farmstead that has lasted for generations.

» MADE IN LANCASTER, PA



AMISH MADE

OLDE FARMSTEAD *Occasional*

» COLLECTION

DESIGNED TO REFLECT OUR ROOTS

FEATURING GENUINE
OLDE WORLD CRAFTSMANSHIP.
BUILT TO LAST GENERATIONS.

- » Mortise and tenon construction, built to last for generations
- » Genuine heat forged, hand-hammered steel bands
- » Hand distressed tops and frames (OPTIONAL)
- » Multi-species design – hardwood maple tops and ash frames
- » Only available with hardwood maple tops



» FEATURE:
**HAND HAMMERED CORNER BRACKET
AND OPTIONAL HAND DISTRESSING**



440

SHOWN: 2T (119) Cappuccino Top with
(346) Green Frost with Rubthrough and Antiquing

440: Olde Farmstead Large End Table

SIZE: 24" D x 24" L x 24" H

FEATURES:

- » Standard with hand hammered steel bands
- » Maple tops / Ash bases
- » Mortise & tenon construction
- » Standard with rough-sawn base
- » (OPTIONAL) hand distressing



447

SHOWN: (104) Seely with Antiquing

447: Olde Farmstead Sofa Table

SIZE: 16" D x 52" L x 30" H

FEATURES:

- » Standard with hand hammered steel bands
- » Maple tops / Ash bases
- » Mortise & tenon construction
- » Standard with rough-sawn base
- » (OPTIONAL) hand distressing

ALSO AVAILABLE WITHOUT STEEL BANDS



445

SHOWN: (104) Seely with Antiquing



441

SHOWN: (104) Seely with Antiquing



444

SHOWN: (104) Seely with Antiquing



442

SHOWN: 2T (119) Cappuccino Top with (346) Green Frost with Rubthrough and Antiquing

444: Olde Farmstead Console Table

SIZE: 16" D x 40" L x 30" H

FEATURES:

- » Standard with hand hammered steel bands
- » Maple tops / Ash bases
- » Mortise & tenon construction
- » Standard with rough-sawn base
- » (OPTIONAL) hand distressing

445: Large Square Coffee Table

SIZE: 38" D x 38" L x 19" H

FEATURES:

- » Standard with hand hammered steel bands
- » Maple tops / Ash bases
- » Mortise & tenon construction
- » Standard with rough-sawn base
- » (OPTIONAL) hand distressing

441: Olde Farmstead Chairside Table

SIZE: 20" D x 19 1/4" L x 24" H

FEATURES:

- » Standard with hand hammered steel bands
- » Maple tops / Ash bases
- » Mortise & tenon construction
- » Standard with rough-sawn base
- » (OPTIONAL) hand distressing

442: Olde Farmstead Cocktail Table

SIZE: 18" D x 42" L x 19" H

FEATURES:

- » Standard with hand hammered steel bands
- » Maple tops / Ash bases
- » Mortise & tenon construction
- » Standard with rough-sawn base
- » (OPTIONAL) hand distressing

AMISH MADE

OLDE FARMSTEAD *Options*



442: Shown with 119 CAPPUCCINO TOP/
346 GREEN FROST/RUB THROUGH BASE



440: Shown with 119 CAPPUCCINO TOP/
346 GREEN FROST/RUB THROUGH BASE

RUB
THROUGH
(OPTIONAL)
ON PAINTED BASES

Amish Made
RENO

OCCASIONAL

RENO

» **COLLECTION**



**IMPORTED FROM
ABSOLUTELY
NOWHERE**

Simplistic – Modern appeal. The Reno Occasional Collection is designed with classy black bases and solid hardwood tops. Their clean, straight lines are a study in simple sophistication. A paradoxical element that creates a refined statement of fashion to your living spaces.

» **MADE IN LANCASTER, PA**

RENO



AMISH MADE

RENO

Occasional

★ NEW ★
Design

» COLLECTION

» AVAILABLE ON ALL THE RENO PIECES:

NEW WORMY MAPLE SPECIES

» STANDARD ON THE 940-945-947:

HEAVY 1 1/2" THICK EDGES



940

SHOWN: (116) Harvest on Wormy Maple



945

SHOWN: (116) Harvest on Wormy Maple

945: Reno Solid Top Coffee Table

SIZE: 28" D x 48" L x 18" H

FEATURES:

» Tops have heavy 1 1/2" thick edges

940: Reno Solid Top End Table

SIZE: 24" D x 24" L x 24" H

FEATURES:

» Tops have heavy 1 1/2" thick edges



947

SHOWN: (116) Harvest on Wormy Maple

947: Reno Solid Top Sofa Table

SIZE: 16" D x 48" L x 30" H

FEATURES:

» Tops have heavy 1 1/2" thick edges



940G

SHOWN: (Natural) on Wormy Maple

» STANDARD ON THE 940G-945G-947G:

GLASS WITH CLASSY 1" BEVEL

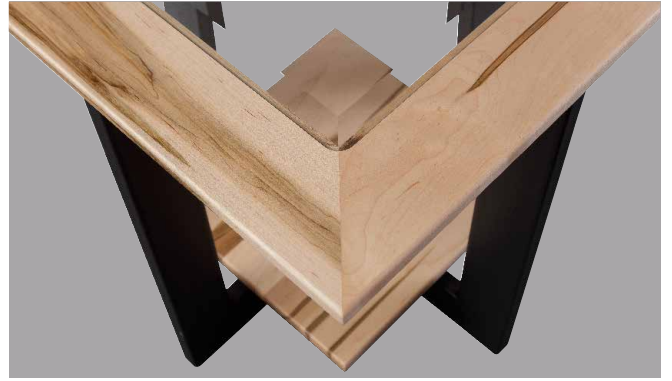

» STANDARD ON ALL THE RENO PIECES:

CLASSY BLACK BASES



945G

SHOWN: (Natural) on Wormy Maple

945G: Reno Glass Top Coffee Table

SIZE: 28" D x 48" L x 18" H

FEATURES:

» 1/4" glass with classy 1" bevel

940G: Reno Glass Top End Table

SIZE: 24" D x 24" L x 24" H

FEATURES:

» 1/4" glass with classy 1" bevel



947G

SHOWN: (Natural) on Wormy Maple

947G: Reno Glass Top Sofa Table

SIZE: 16" D x 48" L x 30" H

FEATURES:

» 1/4" glass with classy 1" bevel

Amish Made

SIMPLICITY

OCCASIONAL

» COLLECTION



SIMPLICITY

**IMPORTED FROM
ABSOLUTELY
NOWHERE**

Meet nostalgia with a modern flare. Welcome to the Simplicity collection. A simplistic design that takes its cues from the Shaker era but with a decidedly modern edge. Reverse beveled tops, tapered legs and beautifully beveled drawer fronts create a cultured appeal without getting complex. Its simplicity mastered

» **MADE IN LANCASTER, PA**

SIMPLICITY



AMISH MADE

★ NEW ★
Design

SIMPLICITY Occasional

» COLLECTION

» 437 FEATURES:



» Lift top for easy access to power ports & storage compartment



» 2 AC, 2 USB power ports



437

SHOWN: 2T Natural top with (121) Smoke base on Rustic Hickory



STANDARD HARDWARE

The Simplicity Occasional collection comes standard with the classy LY96-0B Leyton Pull (3-3/4" C-C)

STANDARD FEATURES



» Stylish reverse beveled tops



» Beveled drawer fronts add a touch of distinction

SHOWN: 2T Natural top with (121) Smoke base on Rustic Hickory



★ NEW ★
Design

433

SHOWN: 2T Natural top with (121) Smoke base on Rustic Hickory



434

437: Simplicity Lifttop Chairside Table

SIZE: 24" D x 15" L x 23" H

FEATURES:

- » Lift top storage area with power port
- » Power port: 2 AC + 2 USB outlets
- » Full extension glides
- » Beveled drawer fronts

433: Simplicity Wedge Table w/ Drawer

SIZE: 24" D x 20-13" L x 23" H

FEATURES:

- » Full extension glides

434: Simplicity Wedge Table

SIZE: 24" D x 16-9" L x 23" H



417

SHOWN: 2T Natural top with (121) Smoke base on Rustic Hickory



424

SHOWN: 2T Natural top with (121) Smoke base on Rustic Hickory



429

SHOWN: 2T Natural top with (121) Smoke base on Rustic Hickory



427

SHOWN: 2T Natural top with (121) Smoke base on Rustic Hickory



429: Simplicity Sofa Table

417: Simplicity Small End Table

424: Simplicity Console Table

427: Simplicity Coffee Table

SIZE: 15" D x 48" L x 29" H

SIZE: 18" D x 18" L x 23" H

SIZE: 15" D x 30" L x 29" H

SIZE: 20" D x 40" L x 18" H

FEATURES:

- » Full extension glides
- » Beveled drawer fronts

FEATURES:

- » Full extension glides
- » Beveled drawer fronts

FEATURES:

- » Full extension glides
- » Beveled drawer fronts



431

SHOWN: 2T Natural top with (121) Smoke base on Rustic Hickory



419

SHOWN: 2T Natural top with (121) Smoke base on Rustic Hickory



425

SHOWN: 2T Natural top with (121) Smoke base on Rustic Hickory



436

SHOWN: 2T Natural top with (121) Smoke base on Rustic Hickory



425: Simplicity Ladies Writing Table

SIZE: 20" D x 40" L x 30" H

FEATURES:

- » Full extension glides
- » Keyboard drawer
- » Beveled Drawer fronts
- » **OPTIONAL H-S2:** Dual USB charging port in bottom of drawer. (See Office section for photos)

431: Simplicity Chairside

SIZE: 24" D x 13 1/2" L x 23" H

FEATURES:

- » Full extension glides
- » Beveled Drawer Fronts

419: Simplicity Large Writing Desk

SIZE: 24" D x 54" L x 30" H

FEATURES:

- » Full extension glides
- » Keyboard drawer
- » Beveled Drawer fronts
- » **OPTIONAL H-S2:** Dual USB charging port in bottom of drawer. (See Office section for photos)

436: Simplicity End Table

SIZE: 28" D x 20" L x 23" H

FEATURES:

- » Full extension glides
- » Beveled Drawer Fronts

Amish Made
OFFICE

COLLECTION

» COUNTRY CLASSIC COLLECTION



★ IMPORTED ★
FROM
ABSOLUTELY
Nowhere

CELEBRATING ^{***} *30* Years

Whether yours is a casual space at home or an executive office at work. What matters is function and style. You can find both in our selection of office furnishings, from smaller multipurpose desks for your living space or student dorm to larger executive desks and accessories for those larger office spaces. No matter your work environment, Make a statement. Work with class.

» MADE IN LANCASTER, PA

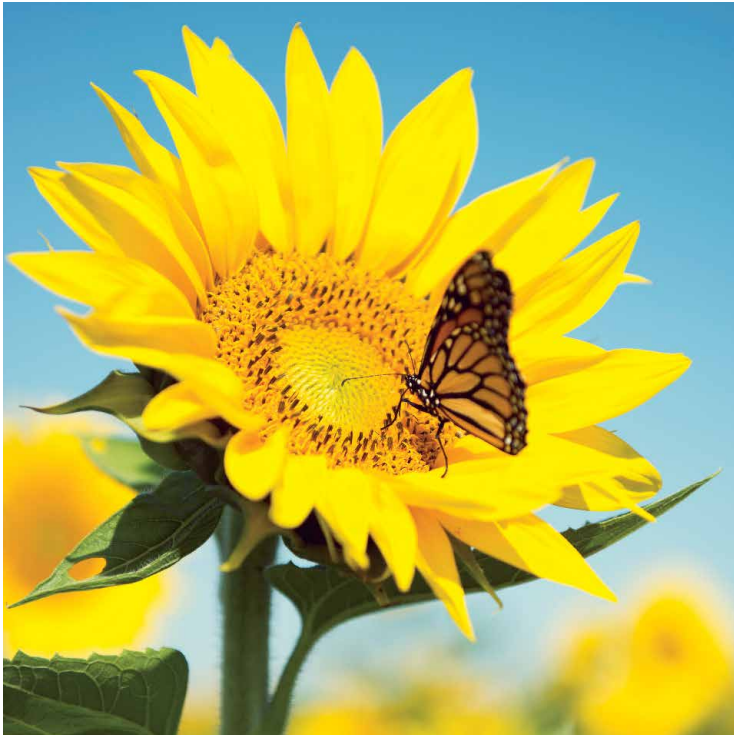

OFFICE

AMISH MADE

MISSION *Office*

» COLLECTION

OFFICE COLLECTION POWER OPTIONS



P-6



OPTIONAL:

Power Strip with 6 AC outlets.

AVAILABLE ON 180-181-191-198-732

Gets mounted in kneehole beneath Keyboard drawer.



H-S2



OPTIONAL:

Dual USB charging port.

AVAILABLE ON ALL DESKS EXCEPT 108-118

419-425-050 Gets mounted in bottom of drawer.



H-L3



OPTIONAL:

Power Hub with 1 AC outlet & 2 USB charging ports.

AVAILABLE ON ALL DESKS EXCEPT 050-108-118

Gets mounted in top.

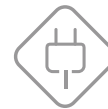

OPTIONAL POWER ICON:

Look for products with this icon.



135 Choose from 10 bonded leather color choices. See the bonded leather page or ask for actual samples.
 SHOWN: (110) Medium on Rustic Cherry



192 SHOWN: (110) Medium on Rustic Cherry



193 SHOWN: (110) Medium on Rustic Cherry



STANDARD HARDWARE

The Mission Office Collection comes standard with the convenient and attractive CP-N/CP-NK: Cup Pull hardware.

193: Mission 3-Drawer File

SIZE: 27" D x 22" L x 43" H
FEATURES:
 » Holds legal or letter files
 » Full extension glides with 100lb capacity

135: Mission Office Chair w/ Gas Lift

SIZE: 25" D x 25" L x 46" H
ARM HEIGHT: 24½" H (Minimum)
FEATURES:
 » Gas lift
 » Available with wood or bonded leather seat
 » 10 bonded leather color choices available

192: Mission 2-Drawer File

SIZE: 27" D x 22" L x 30" H
FEATURES:
 » Holds legal or letter files
 » Full extension glides with 100lb capacity



197

SHOWN: (110) Medium on Rustic Cherry



198

SHOWN: (110) Medium on Rustic Cherry



SHOWN: (110) Medium on Rustic Cherry

191 199



» FEATURE:

198 | 191 STANDARD FEATURES



191/198 OPTIONAL FEATURES

- » H-S2: Dual USB charging port in drawer
- » H-L3: Power Hub with 1- AC outlet & 2- USB ports in top
- » P-6: Power strip with 6-AC outlets with in kneehole

191: Mission 66" Desk

SIZE: 29" D x 66" L x 30" H
KNEEHOLE SIZE: 23" D x 26" W x 25³/₄" H
FEATURES:

- » Keyboard drawer
- » 2 file drawers
- » 2 writing pullouts
- » Full extension glides with 100lb capacity
- » Holds legal or letter files

199: Optional Mission 66" Hutch Top

SIZE: 15" D x 66" L x 45" H
INSIDE DOORS: 11" D x 15¹/₄" L x 27" H
OPEN CENTER: 11" D x 28" L x 20" H
FEATURES:

- » Only available for 191 desk
- » Standard with LED desktop lighting
- » 2 side shelves
- » 1 center shelf

197: Mission 2-Drawer Lateral File

SIZE: 21¹/₄" D x 34¹/₂" L x 30" H
FEATURES:

- » Full extension glides with 100lb capacity
- » Holds legal or letter files

198: Mission 55" Desk

SIZE: 25" D x 55" L x 30" H
KNEEHOLE SIZE: 19" D x 23" W x 25³/₄" H
FEATURES:

- » Keyboard drawer
- » 2 file drawers
- » 2 writing pullouts
- » Full extension glides with 100lb capacity
- » Holds legal or letter files



181

— SHOWN: (227) Rich Cherry on Maple Wood



» 180-181 FEATURE:

| PANELED - FINISHED BACK



» 180-181 FEATURE:

| KEYBOARD DRAWER



» 180-181 FEATURE:

| FILE DRAWER



180

— SHOWN: (227) Rich Cherry Top with (342) Country White Rubthrough with Provincial Glaze on Maple Wood



180: Mission 55" Executive Desk

181: Mission 66" Executive Desk

OPTIONAL FEATURES

SIZE: 25" D x 55" L x 30" H

KNEEHOLE SIZE: 21" D x 22¹/₂" W x 25³/₄" H

FEATURES:

- » Keyboard drawer
- » File drawer
- » Full extension glides with 100lb capacity

SIZE: 29" D x 66" L x 30" H

KNEEHOLE SIZE: 25" D x 26" W x 25³/₄" H

FEATURES:

- » Keyboard drawer
- » File drawer
- » Full extension glides with 100lb capacity

- » **H-S2:** Dual USB charging port in drawer
- » **H-L3:** Power Hub with 1- AC outlet & 2- USB ports in top
- » **P-6:** Power strip with 6-AC outlets with in kneehole



» FEATURE:

032 | 050 KEYBOARD DRAWER



050

SHOWN: (116) Harvest on Red Oak



032

SHOWN: (116) Harvest on Red Oak

032: Mission Library Desk

SIZE: 25" D x 50" L x 30" H

FEATURES:

- » Keyboard drawer
- » Full extension glides
- » **OPTIONAL H-S2:** Dual USB charging port in drawer
- » **OPTIONAL H-L3:** Power Hub with 1- AC outlet & 2- USB ports in top

050: Mission Computer Table

SIZE: 20" D x 32" L x 30" H

FEATURES:

- » Keyboard drawer
- » Full extension glides
- » **OPTIONAL H-S2:** Dual USB charging port in drawer

BOOKCASE *Options*

DESIGN YOUR IDEAL BOOKCASE OR WALL UNIT

This program is designed to allow you to choose exactly what you need in depth, width, height and door styles. All from seven simple items. With this easy to use program you can create wall units, entertainment towers or just order single bookcases for your home. Simply follow the easy to use ordering instructions. It is easy to order & a breeze to customize!

» Height Options

Options available to create your ideal bookcase:

- » Available in 7 different heights: 30 – 36 – 48 – 60 – 72 – 84 – 92
- » Available in 4 different depths: 12 – 16 – 20 – 24
- » Available in 7 different widths: 18 – 24 – 30 – 36 – 42 – 48 – 60*
- » Paneled or solid sides
- » Optional doors: flat panel, raised panel or glass
- » Crown molding
- » Flush sides to create wall units

*60" wide will come with divider in center.



Standard Features

- » Fitted backs and pocket screw construction ensure lasting strength
- » Adjustable solid wood shelves
- » All 72" H and 84" H units feature one fixed shelf for added stability
- » 60" wide units come with a divider in the center to increase stability

BOOKCASE

Options

THE OPTIONS YOU WANT — THE EASE YOU NEED

Follow these simple steps to create and order the ideal wall solutions.

STEP 1 » Choose your height

B30 - 30" H **B72** - 72" H
B36 - 36" H **B84** - 84" H
B48 - 48" H **B92** - 92" H
B60 - 60" H

STEP 2 » Choose your depth

» 12" D
 » 16" D
 » 20" D
 » 24" D

STEP 3 » Choose your width

» 18" W » 42" W
 » 24" W » 48" W
 » 30" W » 60" W*
 » 36" W

*60" wide will come with divider in center.

STEP 4 » Choose your side style



PS: Panel Sides



S: Solid Sides

STEP 5 » Choose a door style, if desired, or leave it open



FP: Flat Panel Door



RP: Raised Panel Door



G: Glass Door

Note:

- » Doors for 30 to 48" height bookcases are Full Length.
- » All other heights are 24" door on bottom of cabinet.
- » Doors can also be ordered for top of cabinets. Must be clearly specified!

STEP 6 » If desired, choose a custom trim style



C: Crown Molding



Flush cut tops to create wall units

- F2: Flush cut both sides
- FL: Flush cut left side
- FR: Flush cut right side

STEP 7 » Receive your dream wall unit



Note:

- » Depth - Width - Height are size of cabinet. Top not included.
- » Top thickness is 3/4"
- » Top overhang is 3/4" in front and on each side - 1 1/2" if ordered with Crown molding

» ORDERING INSTRUCTIONS

Item code for ordering as follows: (Examples Below) » Item code – depth – width – sides – door option – molding

- » **B30-16-24-S-G** is a bookcase 30 H x 16 D x 24 W with solid sides and glass doors
- » **B48-12-42-P-FP-C** is a bookcase 48 H x 12 D x 42 H with paneled sides, flat panel doors and crown molding

STANDARD FEATURES

STANDARD FEATURES

- » File drawer/holds letter or legal paper
- » Classy side panels
- » Dual usb charging port in keyboard drawer

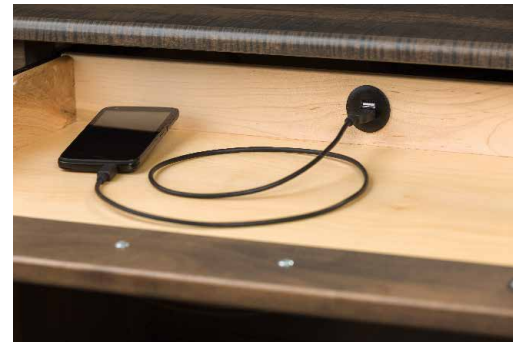

732

SHOWN: (121) Smoke on Maple Wood

OPTIONAL FEATURES

OPTIONAL FEATURES:

- » **H-L3:** power hub » 1 ac outlet » 2 usb charging ports
- » **P-6:** Power strip » 6 ac outlets (gets mounted in back of kneehole)



P-6

H-L3

732: Crossway Students Desk

OPTIONAL H-L3: Large Hub/USB Ports

OPTIONAL P-6: Power Strip

SIZE: 20" D x 50" L x 30" H
 KNEEHOLE SIZE: 18" D x 30" W x 25³/₄" H
 FEATURES:

FEATURES:
 » Large Hub with 1 AC outlet and 2 USB ports

FEATURES:
 » Power strip with 6 AC Outlets

- » Keyboard drawer
- » **H-S2:** Dual USB charging port in KB drawer
- » File drawer holds legal or letter files
- » Wiring hole in top with wooden grommet

» FEATURE:

118 STORAGE DETAIL



118

SHOWN: (116) Harvest on Red Oak



108

SHOWN: (116) Harvest on Red Oak

108: Mission Secretary Laptop Desk

SIZE: 15" D x 24 1/4" L x 41" H
TOP SHELF: 7" D x 20 1/4" L x 6" H
LID SPACE: 12 1/2" tapers 9 1/4" D x 20 1/4" W
DOOR SPACE: 12 1/2" D x 20 1/4" L x 7" H
FEATURES:

- » Full extension glides
- » Small supply shelf behind lid

118: Mission Large Secretary Desk

SIZE: 19 1/4" D x 36 1/4" L x 41" H
TOP SHELF: 11" D x 32 1/4" L x 6" H
LID SPACE: 16 1/2" tapers 13" D x 32 1/4" W
DOOR SPACE: 16 1/2" D x 15 1/2" L x 16" H
FEATURES:

- » Full extension glides
- » File drawer and supply shelves
- » 1 adjustable shelf



419

SHOWN: 2T Natural top with (119) Cappuccino base on Rustic Hickory



425

SHOWN: 2T Natural top with (119) Cappuccino base on Rustic Hickory

425: Simplicity Ladies Writing Table

419: Simplicity Large Writing Desk

SIZE: 20" D x 40" L x 30" H

FEATURES:

- » Full extension glides
- » Keyboard drawer
- » Beveled Drawer fronts
- » **OPTIONAL H-S2:** Dual USB charging port in bottom of drawer.

SIZE: 24" D x 54" L x 30" H

FEATURES:

- » Full extension glides
- » Keyboard drawer
- » Beveled Drawer fronts
- » **OPTIONAL H-S2:** Dual USB charging port in bottom of drawer.

Amish Made

ENTERTAINMENT

COLLECTION

» COUNTRY CLASSIC COLLECTION



★ IMPORTED ★
FROM
ABSOLUTELY
Nowhere

CELEBRATING ^{***} *30* Years

More than a place for media components, Entertainments and media centers make great accent pieces. Regardless of the size of your living space or bedroom you will find and entertainment that's right for you. Like the style but need a different size? Just ask. We will build it to perfectly fit your space and needs. Customization. So you can always entertain in style!

» MADE IN LANCASTER, PA



AMISH MADE

ENTERTAINMENT

Collection



729

SHOWN: (121) Smoke on Maple



089

SHOWN: (116) Harvest on Red Oak



064

SHOWN: (116) Harvest on Red Oak



098

SHOWN: (116) Harvest on Red Oak



064: Mission TV Table

SIZE: 20" D x 30" L x 29" H

TOP SHELF: 16 1/2" D x 23" L x 5" H

BOTTOM SHELF: 16 1/2" D x 23" L x 10" H

FEATURES:

» Full extension glides

729: Crossway Large Ent. Table

SIZE: 18" D x 56" L x 29" H

SIDE SHELF: 9" D x 13 3/4" L x 9 1/2" H

CENTER SLOT: 15 1/2" D x 33 1/4" L x 20 1/2" H

FEATURES:

» Full extension glides

» 2 adjustable shelves

089: Mission Large Ent. Table

SIZE: 18" D x 56" L x 30" H

CENTER SPACE: 13" D x 32" L x 20" H

SIDE SHELVES: 6 1/2" D x 12" L x 10 1/2" H

FEATURES:

» 2 adjustable center shelves

» 4 side shelves

098: Mission Entertainment Table

SIZE: 18" D x 42" L x 23 1/2" H

CENTER SPACE: 13 3/4" D x 18" L x

17" H

SIDE SHELVES: 6 1/2" D x 12" L x 8" H

FEATURES:

» 1 adjustable center shelf

» 4 side shelves



100B

SHOWN: (116) Harvest on Red Oak



117G

SHOWN: (116) Harvest on Red Oak

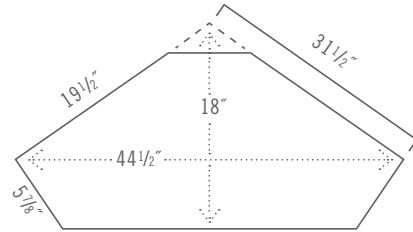

» SPEC:

119 | 119G FOOTPRINT



119G

SHOWN: (116) Harvest on Red Oak



119

SHOWN: (116) Harvest on Red Oak



119G: Mission Corner Ent. Cabinet

100B: Mission TV Ent. Center

117G: Mission 3 Door Media Cabinet

119: Mission Corner Ent. Cabinet

SIZE: 18" D x 44¹/₄" L x 30" H
SLOT SPACE: 18" D x 32" L x 5³/₄" H
INSIDE DOORS: 18" D x 32" L x 15³/₄" H
FEATURES:

- » Adjustable shelf
- » Glass doors

SIZE: 20" D x 62" L x 32" H
GLASS DOORS: 17³/₄" D x 29" L x 25" H
WOOD DOORS: 17³/₄" D x 12" L x 25" H
FEATURES:

- » 2 adjustable center shelves
- » 2 adjustable shelves each side
- » comes with wheels

SIZE: 20" D x 53" L x 30" H
CENTER DOOR: 18" D x 17¹/₂" L x 22" H
SIDE DOORS: 18" D x 12¹/₂" L x 22" H
FEATURES:

- » 2 adjustable center shelves
- » 2 adjustable shelves each side
- » Center glass door

SIZE: 18" D x 44¹/₄" L x 30" H
SLOT SPACE: 18" D x 32" L x 5³/₄" H
INSIDE SPACE: 18" D x 32" L x 15³/₄" H
FEATURES:

- » Adjustable shelf



117

SHOWN: (116) Harvest on Red Oak



105

SHOWN: (116) Harvest on Red Oak

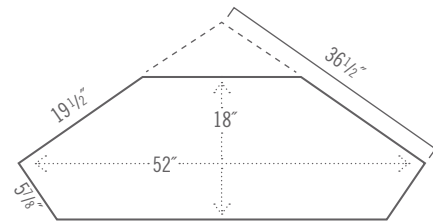

» SPEC:

120 | 120G FOOTPRINT



120

SHOWN: (116) Harvest on Rustic Cherry



120G

SHOWN: 2T Natural Top with (121) Smoke on Rustic Cherry



120: Mission Corner Entertainment

117: Mission 2-Door Media Cabinet

105: Mission TV Entertainment Cabinet

120G: Mission Corner Entertainment

SIZE: 18" D x 52" L x 30" H

INSIDE DOORS: 15" D x 39 1/2" L x 16 1/4" H

COMPONENT SLOT: 15" D x 39 1/2" L x 5 1/2" H

FEATURES:

» Adjustable shelf

SIZE: 20" D x 53" L x 30" H

CENTER: 18" D x 17 1/2" L x 22" H

SIDE DOORS: 18" D x 12 1/2" L x 22" H

FEATURES:

» 2 adjustable center shelves

» 2 adjustable shelves each side

SIZE: 20" D x 44" L x 30" H

SLOT SPACE: 17 3/4" D x 35 1/2" L x 5 1/2" H

INSIDE SPACE: 17 3/4" D x 35 1/2" L x 16" H

FEATURES:

» Adjustable shelf

SIZE: 18" D x 52" L x 30" H

INSIDE DOORS: 15" D x 39 1/2" L x 16 1/4" H

COMPONENT SLOT: 15" D x 39 1/2" L x 5 1/2" H

FEATURES:

» Adjustable shelf

» Glass doors



148

SHOWN: Natural on Rustic Cherry



249

SHOWN: (225) Mission Maple on Rustic Cherry

249: Craftsmen 56" Entertainment

SIZE: 19" D x 56" L x 30" H
SIDE SHELF: 6 1/2" D x 14" L x 10" H
CENTER SLOT: 14" D x 37" L x 21" H
FEATURES:
 » Full extension glides
 » 2 adjustable shelves



147

SHOWN: (108) S-14 on Rustic Cherry

147: Craftsmen Entertainment Center

SIZE: 18" D x 46" L x 30" H
INSIDE SIZE: 15" D x 40" L x 22" H
FEATURES:
 » 2 adjustable shelves

148: Craftsmen 4-Door Ent. Credenza

SIZE: 18" D x 65" L x 36" H
INSIDE CENTER: 15" D x 29" L x 20" H
INSIDE SIDE: 15" D x 12" L x 20" H
CENTER SLOT: 15" D x 28" L x 6 1/2" H
DRAWERS: 13" D x 10" L x 5 3/4" H
FEATURES:
 » 2 adjustable shelves each side
 » 2 adjustable center shelves



898

SHOWN: (227) Rich Cherry on Maple



657

SHOWN: (051) Black on Maple



657: Manhattan Credenza/Ent.

898: Monarch Entertainment Table

SIZE: 16½" D x 56" L x 30" H
DOOR SPACE: 14" D x 24" L x 16" H

FEATURES:

- » Full extension glides
- » Glass doors for easy remote access
- » One adjustable shelf

SIZE: 18" D x 42" L x 29" H
CENTER SPACE: 13" D x 20¼" L x 19" H
SIDE SHELVES: 7" D x 13" L x 9" H

FEATURES:

- » 2 adjustable shelves



★ IMPORTED ★
FROM
ABSOLUTELY
Nowhere

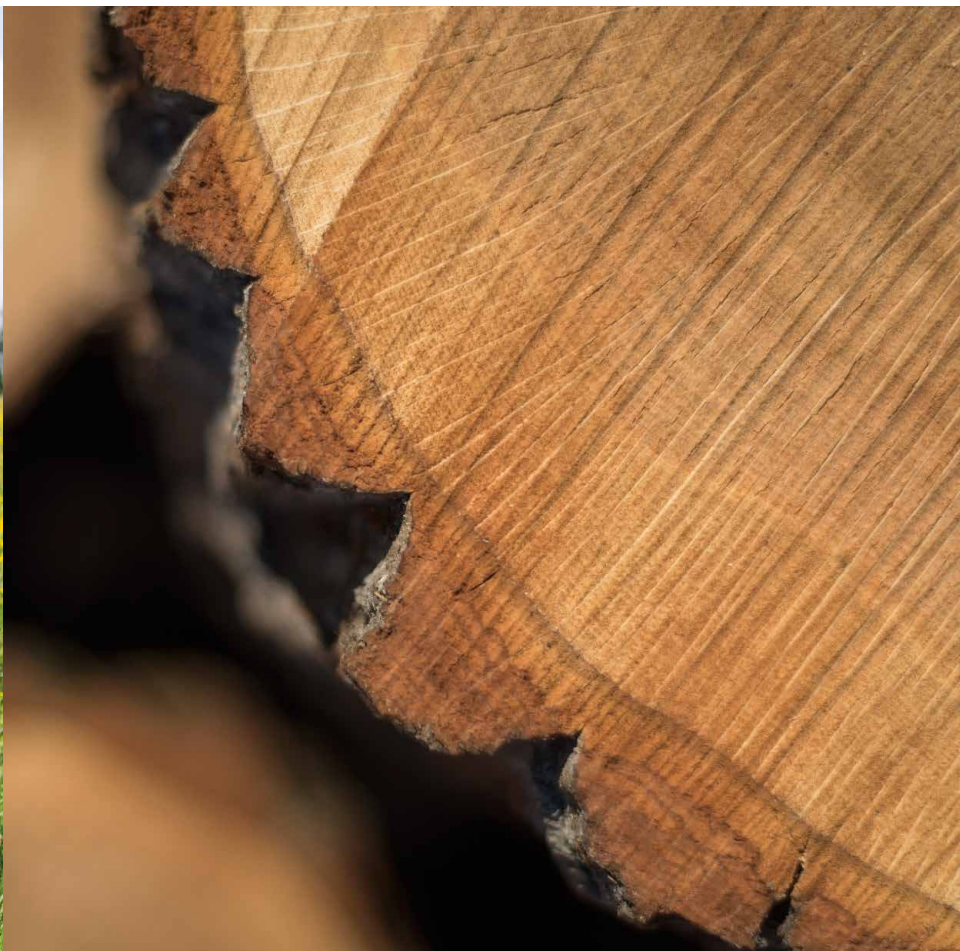



★ CELEBRATING ★
30 Years
OF ADDING *Value &*
GOING STRONG

COUNTRY CLASSIC COLLECTION

Our furniture is built to satisfy with your choice of color, hardware, wood species and even dimensional changes! It is built in America by Amish Craftsmen in the heart of PA Dutch Country, from start to finish. We take pride in each piece we build, from the solid wood construction to our beautiful finishes. After meeting our high standards of quality, every piece gets branded with the Country Classic Collection logo to ensure you are getting a genuine Amish handcrafted work of art. We hope you will enjoy the usefulness and style for many generations.

» MADE IN LANCASTER, PA

